



**Two-laning of Highways
through
Public Private Partnership**

**MANUAL
OF
SPECIFICATIONS & STANDARDS**

**Planning Commission
Government of India
New Delhi**

IRC:SP:73-2007

This is a technical document which has been produced by the Indian Roads Congress. For any further technical clarifications please contact:

*Secretary General
The Indian Roads Congress
Sector 6, R.K. Puram
New Delhi-110 022*

*Published by the Secretariat for the Committee on Infrastructure
Planning Commission
Yojana Bhavan
Parliament Street
New Delhi-110 001*

*Printed by Brijbasi Art Press Ltd.
A-81, Sector-5, Noida - 201 203*

Reprint: May 2010.

Contents

| | |
|--|------|
| Foreword | ix |
| Preface | xiii |
| List of Symbols and Abbreviations | xvi |
| 1 General | 3 |
| 2 Geometric Design and General Features | 11 |
| 2.1 General | 11 |
| 2.2 Design Speed | 12 |
| 2.3 Right-of-Way | 12 |
| 2.4 Lane width of Carriageway | 13 |
| 2.5 Shoulders | 13 |
| 2.6 Roadway Width | 14 |
| 2.7 Camber or Crossfall | 14 |
| 2.8 Horizontal Alignment | 15 |
| 2.9 Sight Distance | 17 |
| 2.10 Vertical Alignment | 18 |
| 2.11 Lateral and Vertical Clearance at Underpasses | 18 |
| 2.12 Lateral and Vertical Clearance at Overpasses | 19 |
| 2.13 Service Roads | 19 |
| 2.14 Grade separated Structures | 19 |
| 2.15 Typical Cross Sections | 20 |
| 2.16 Capacity of two lane highway | 20 |
| 3 Intersections and Grade Separators | 27 |
| 3.1 Intersections | 27 |
| 3.2 At-grade Intersections | 27 |
| 3.3 Grade Separated Intersections without ramps | 29 |
| 3.4 Interchanges | 30 |

| | | |
|----------|---|-----------|
| 4 | Road Embankment and Cuttings | 35 |
| 4.1 | General | 35 |
| 4.2 | Road Embankment | 35 |
| 4.3 | Roadway in Cutting | 41 |
| 4.4 | Soil Survey Investigations and Design Report | 42 |
| | | |
| 5 | Pavement Design | 47 |
| 5.1 | General | 47 |
| 5.2 | Method of Design of Flexible Pavements | 47 |
| 5.3 | Method of Design of Rigid Pavements | 48 |
| 5.4 | Design of New Pavements | 48 |
| 5.5 | Design Traffic | 49 |
| 5.6 | Subgrade | 50 |
| 5.7 | Pavement Components and Materials | 50 |
| 5.8 | Performance Evaluation | 52 |
| 5.9 | Widening and Strengthening of Existing Road to Two Lane with Paved Shoulders | 53 |
| 5.10 | Design of Strengthening Treatment (Overlay) | 55 |
| 5.11 | Construction, Workmanship and Quality of Work | 57 |
| 5.12 | Premature Distress | 57 |
| 5.13 | Detailed Design Report | 58 |
| | | |
| 6 | Roadside Drainage | 63 |
| 6.1 | General | 63 |
| 6.2 | Surface Drainage | 63 |
| 6.3 | Median Drainage | 64 |
| 6.4 | Drainage of High Embankment | 64 |
| 6.5 | Catch Water Drains | 65 |
| 6.6 | Sub-surface Drains | 65 |
| 6.7 | Internal Drainage of Pavement Structures | 67 |
| 6.8 | Survey, Investigations and Design Report | 67 |
| | | |
| 7 | Design of Structures | 71 |
| 7.1 | General | 71 |
| 7.2 | Design Loading and Stresses | 71 |

| | | |
|----------|--|-----------|
| 7.3 | Widening/reconstruction of existing structures | 72 |
| 7.4 | Structure Types | 72 |
| 7.5 | Hydrology | 73 |
| 7.6 | Sub-Surface Investigations | 73 |
| 7.7 | Culverts | 73 |
| 7.8 | Prestressing | 74 |
| 7.9 | Form Work | 75 |
| 7.10 | Foundation and Sub-structures | 76 |
| 7.11 | Approach Slab | 78 |
| 7.12 | Superstructure | 78 |
| 7.13 | Bearings | 78 |
| 7.14 | Expansion Joints | 79 |
| 7.15 | Wearing Coat | 79 |
| 7.16 | Earth Retaining Structures | 80 |
| 7.17 | River Training and Protective Works | 80 |
| 7.18 | Safety Barriers | 80 |
| 7.19 | Rail Road Bridges | 81 |
| 7.20 | Grade Separated Road Structures | 82 |
| 7.21 | Drainage | 82 |
| 7.22 | Structure in Marine Environment | 82 |
| 7.23 | Repairs and Strengthening | 82 |
| 7.24 | Design Report | 83 |
| 8 | Materials and Specifications for Structures | 89 |
| 8.1 | General | 89 |
| 8.2 | Structural Concrete | 90 |
| 8.3 | Cement | 91 |
| 8.4 | Coarse Aggregates | 91 |
| 8.5 | Sand/Fine Aggregates | 91 |
| 8.6 | Water | 92 |
| 8.7 | Concrete Admixture | 92 |
| 8.8 | Steel | 94 |
| 8.9 | Storage of Materials | 95 |
| 8.10 | Reports to be submitted | 95 |

| | | |
|-----------|--|-----|
| 9 | Traffic Control Devices and Road Safety Works | 99 |
| 9.1 | General | 99 |
| 9.2 | Road Markings | 99 |
| 9.3 | Road Signs | 99 |
| 9.4 | Road Side Safety Barriers | 103 |
| 9.5 | Safety during Construction | 107 |
| 9.6 | Design Report | 107 |
| | | |
| 10 | Toll Plazas | 117 |
| 10.1 | General | 117 |
| 10.2 | Location of Toll Plaza | 117 |
| 10.3 | Land for Toll Plaza | 117 |
| 10.4 | Layout and Design of Toll Plaza | 117 |
| 10.5 | Tollbooths | 119 |
| 10.6 | Road Works | 119 |
| 10.7 | Traffic Signs | 120 |
| 10.8 | Road Markings | 120 |
| 10.9 | Toll Plaza Complex | 120 |
| 10.10 | Check/Barriers Gate | 121 |
| 10.11 | Lighting | 121 |
| 10.12 | Water Supply | 122 |
| 10.13 | Fire Fighting System | 122 |
| 10.14 | Report to be submitted | 122 |
| | | |
| 11 | Roadside Furniture | 135 |
| 11.1 | General | 135 |
| 11.2 | Road Boundary Stones (RBS) | 135 |
| 11.3 | Kilometer and 200m Stones | 135 |
| 11.4 | Roadside railings/Pedestrian Guard rails | 135 |
| 11.5 | Overhead Traffic Signs | 137 |
| 11.6 | Traffic Impact Attenuators | 137 |
| 11.7 | Road Delineators | 138 |

| | | |
|-----------|--|-----|
| 12 | Landscaping and Tree Plantation | 141 |
| 12.1 | General | 141 |
| 12.2 | Design consideration in various locations | 141 |
| 12.3 | Maintenance of Plants | 143 |
| 13 | Project Facilities | 147 |
| 13.1 | General | 147 |
| 13.2 | Pedestrian Facilities | 147 |
| 13.3 | Street Lighting | 148 |
| 13.4 | Truck Lay byes | 150 |
| 13.5 | Bus Bays and Bus Shelters | 150 |
| 13.6 | Cattle Crossings | 152 |
| 13.7 | Traffic Aid Posts | 153 |
| 13.8 | Medical Aid Posts | 153 |
| 14 | Special Requirements for Hill Roads | 159 |
| 14.1 | General | 159 |
| 14.2 | Set back Distance at Horizontal Curves | 159 |
| 14.3 | Grade Compensation at Curves | 160 |
| 14.4 | Hairpin Bends | 160 |
| 14.5 | Climbing Lane | 160 |
| 14.10 | Retaining Walls | 161 |

Appendices

| | | |
|------------|--|-----|
| Appendix-1 | List of Paras for Preparing Schedules of the Concession Agreement | 165 |
| Appendix-2 | List of IRC Publications | 167 |



Foreword

The Government of India has initiated an ambitious National Highways Development Programme (NHDP) that relies substantially on Public Private Partnerships (PPPs) as a means of attracting private capital, improving efficiencies and reducing costs. Several states are pursuing similar programmes based on PPPs in state highways, while a few others are in different stages of the process.

For awarding PPP projects within a competitive, efficient and economic framework based on international best practices, Government of India has adopted a Model Concession Agreement (MCA) for PPPs in National Highways. On similar lines, the Planning Commission has published an MCA for State Highways. These MCAs follow the Design, Build, Finance and Operate (DBFO) approach that requires the Concessionaire to bear the responsibility for detailed design. However, the accountability for providing safe and reliable roads ultimately rests with the Government and the MCA, therefore, mandates a Manual of Standards and Specifications that the concessionaire must conform to.

Consistent with the DBFO approach, only the core requirements of design, construction, operation and maintenance of the project highway are to be specified. In sum, the framework should focus on the 'what' rather than the 'how' in relation to the delivery of services by the concessionaire. This would enable cost efficiencies to occur because the shift to output-based specifications would provide the private sector with a greater opportunity to add value by innovating and optimising on designs in a way normally denied to it under conventional input-based procurement specifications.

For evolving standards conforming to the DBFO approach, the Planning Commission asked the Indian Roads Congress (IRC), the apex institution of highway engineers in India, to

develop this Manual of Specifications and Standards for two-lane highways. The Manual would, by reference, form an integral part of the MCA and would be binding on the concessionaire. Its provisions would be enforceable and any breach would expose the concessionaire to penalties, including termination of the concession.

The Manual has been evolved after extensive consultations with experts and stakeholders. Following the conventions of IRC, deliberation on this Manual were undertaken by its Project Preparation (G-1) Committee, General Standards and Specifications Committee, Executive Committee and the Council of Indian Roads Congress, in that order. These fora include experts drawn from the Central and State governments, private sector entities, academia and research organisations. The Manual is now an approved technical document of the IRC and stands at par with other IRC documents that are widely followed across the country by way of codal provisions. Road building agencies of the Central and State Governments could either adopt this Manual in its present form or make such modifications as may be relevant for their purposes. In the latter case, they should publish the modified Manual so that it could be applied, by reference, to their respective PPP projects.

The Manual is to be used in relation to Schedule D of the MCA. Besides integrating this Manual into the concession agreement, the said schedule permits deviations from the Manual to address project-specific requirements. However, all such deviations would need to be stated precisely with a view to enabling bidders to assess their costs with some degree of accuracy.

Since the concessionaire would be contractually bound by the provisions of the Manual, care has been taken to ensure that it is consistent with the provisions of the MCA. These standard documents should enable the respective Governments to take up a large programme for development of safe and reliable roads through PPPs, with least cost to the users and to the public exchequer. The Manual reflects a delicate balance that was

arrived at after several rounds of expert and stakeholder deliberations with a view to ensuring development of quality roads and at the same time improving their financial viability by optimizing on costs and obligations. Modifications, if any, should be made by the executing agencies with due regard to their legal, financial and technical implications on the underlying contractual framework.

The office-bearers of IRC, especially its President and Secretary General and the Chairpersons of the relevant Committees, are to be complimented for their commendable effort in producing this volume with the assistance of eminent experts. Their contribution would go a long way towards the development of highways through PPPs - a modality that has become inevitable for attracting ever larger volumes of investment to this sector.



(Gajendra Haldea)

Adviser to Deputy Chairman,
Planning Commission

May 20, 2007



Preface

There is an urgent need to improve the existing State Highways, at least to 2-lane standards, to ensure balanced road network connectivity in the country. Availability of funds, to undertake this gigantic task, by the States has remained a serious constraint so far. With a view to attracting private investment for the development of State roads, the Planning Commission has recently brought out a "Model Concession Agreement" for Public Private Partnership. Schedule-D of the Model Concession Agreement prescribes for preparation of a Manual of Specifications and Standards by State PWDs for compliance by the Concessionaire. It was felt that a Standard Manual of Specifications and Standards should be brought out by the Indian Roads Congress (IRC) to ensure uniformity of approach and to facilitate easy implementation by various State Governments. Accordingly, the Planning Commission, Govt. of India entrusted the work to IRC.

An Expert Group comprising the following was constituted by the IRC for preparation of the Manual.

- (i) Shri D.P. Gupta : Former Director General
(Road Development)
- (ii) Shri S.C. Sharma : Former Director General
(Road Development)
- (iii) Shri N.K. Sharma : Technical Advisor, IRC

The first draft document prepared by the Expert Group was submitted to the Project Preparation (G-1) Committee of the IRC in September, 2006. The Committee constituted a Sub-Group comprising of S/Shri S.K. Nirmal, K. Venkata Ramana and Pranavant, General Managers, National Highways Authority of India to examine the draft document in greater detail. The Expert Group subsequently modified the draft by incorporating the comments of G-1 Committee. The modified draft was approved

by G-1 Committee in its meeting held on 7th January, 2007. This draft was considered and approved by the General Specifications and Standards (GSS) Committee with some observations in its meeting held on 31st January, 2007. The amended draft was approved by the Executive Committee of the IRC on 6th February, 2007 with the direction that the same should be got reviewed by the Stakeholders. The draft was reviewed by the Stakeholders at a Workshop held in the IRC on 12th February, 2007 where a few suggestions were made. Considering the urgency in the matter, a Special Council Meeting of the IRC was convened on 24th February, 2007 for consideration of the draft.

The Council discussed the draft at length and directed the Secretary General, IRC to examine the comments and get the draft modified by the Expert Group. This modified draft was further discussed by a Committee comprising of Shri G. Sharan, Additional Director General, MOSRTH (Convenor, GSS Committee), Shri Nirmaljit Singh, Member (Tech.), NHAI (Co-Convenor, GSS Committee), Shri S.K. Puri, Chief General Manager, NHAI (Convenor, G-1 Committee), Shri V.K. Sinha, Secretary General, IRC, Shri A.P. Bahadur, Chief Engineer, MOSRTH, along with Shri R.K. Jain, Shri G.S. Khinda, Shri M.V.B. Rao, Technical Advisors, IRC and Shri Sharad Varshney, Additional Director (Tech.), IRC. After detailed deliberations and number of modifications, the draft was finally approved for publication by IRC.

An attempt has been made to adopt a balanced approach to bring in the latest technology and specifications, at the same time, keeping the cost of projects within manageable limits so as to attract more entrepreneurs. A document of this nature cannot remain static in view of the continuous up-gradation of technology over the years. Users of this Manual are going to be the best judge of the deficiencies, if any, in the document. Their feedback and suggestions will be greatly valued by IRC to keep this document updated measuring upto the expectations of the users.

IRC expresses its gratitude to the various members whose names have been mentioned above and other members of different Committees including members of IRC Council who have taken great pains and contributed immensely in finalisation of this Manual. The efforts made by the officers and staff of IRC are also acknowledged. The painstaking efforts put in by Shri D.P. Gupta, Shri S.C. Sharma and Shri R.S. Sharma, former Secretary General, IRC are gratefully acknowledged. Special appreciation is extended to Shri Gajendra Haldea, Advisor to Deputy Chairman, Planning Commission who has inspired the IRC and effectively monitored the preparation of this Manual.

I am confident that this Manual will serve its intended purpose as part of the Model Concession Agreement for Public Private Partnership in Highways.



(V.K. Sinha)

Secretary General, IRC

April 2007

List of Symbols and Abbreviations

| | | |
|--------|---|--|
| AASHTO | : | American Association of State Highway and Transportation Officials |
| ADT | : | Average Daily Traffic |
| ASTM | : | American Society for Testing and Materials |
| BI | : | Bump Integrator |
| BIS | : | Bureau of Indian Standards |
| CBR | : | California Bearing Ratio |
| COD | : | Commercial Operation Date |
| HDPE | : | High Density Polyethylene |
| HYSYD | : | High Yield Strength Deformed (Bars) |
| IE | : | Independent Engineer |
| IRC | : | Indian Roads Congress |
| IS | : | Indian Standards |
| LCV | : | Light Commercial Vehicle |
| LL | : | Liquid Limit |
| MCA | : | Model Concession Agreement |
| MOSRTH | : | Ministry of Shipping, Road Transport & Highways |
| NBC | : | National Building Code |
| NHAI | : | National Highways Authority of India |
| OMC | : | Optimum Moisture Content |
| PCC | : | Plain Cement Concrete |
| PCU | : | Passenger Car Unit |
| PHPD | : | Peak Hour Peak Direction |
| PPM | : | Parts per million |
| PSC | : | Prestressed Concrete |
| QAM | : | Quality Assurance Manual |
| QAP | : | Quality Assurance Plan |
| QS | : | Quality System |
| RCC | : | Reinforced Cement Concrete |
| ROB | : | Road over Bridge (Road over railway line) |
| ROW | : | Right of Way |
| RUB | : | Road under Bridge (Road under railway line) |
| TMT | : | Thermo Mechanically Treated |
| VDF | : | Vehicle Damage Factor |

Section 1
General



SECTION 1

GENERAL

- 1.1 The scope of the work shall be as defined in the Concession Agreement. Two Laning/ Two Laning with Paved Shoulders of the Project Highway shall be undertaken and completed by the Concessionaire as per the Specifications and Standards set forth in this Manual.
- 1.2 The Project Highway and the project facilities shall conform to the design requirements set out in this Manual which are the minimum prescribed. The project report and other information provided by the Government shall be used by the Concessionaire only for its own reference and for carrying out further investigations. The Concessionaire shall be solely responsible for undertaking all the necessary surveys, investigations and detailed designs in accordance with the good industry practice and due diligence, and shall have no claim against Government for any loss, damage, risk, costs, liabilities or obligations arising out of or in relation to the project report and other information provided by the Government.
- 1.3 Alternative designs and Specifications for the pavement and structures (bridges, culverts, underpasses, subways, overpasses, road over/under bridges, retaining walls, reinforced earth walls etc.) may be adopted by the Concessionaire in accordance with design requirements set out in this Manual and three copies of each shall be sent to the Independent Engineer (the "IE") for review and comments, if any. In particular, such comments shall specify the conformity, or otherwise, of such designs and Specifications with the requirements specified in this Manual. The conditions specified in subsequent para 1.13 may also be referred to.
- 1.4 At least two weeks prior to commencement of the work, the Concessionaire shall draw up a Quality Assurance Manual (QAM) covering the Quality System (QS), Quality Assurance Plan (QAP) and documentation for all aspects of the bridge and road works and send three copies each to the IE for review. The class of quality assurance shall not be less than Q-3.
- 1.5 The Codes, Standards and Technical Specifications applicable for the design of project components are:
 - (i) Indian Roads Congress (IRC) Codes and Standards, as per Appendix-2.

- (ii) Specifications for Road and Bridge Works, Ministry of Shipping, Road Transport & Highways hereinafter referred to as MOSRTH Specifications.
 - (iii) Any other standards referred to in the Manual and any supplement issued with the bid document.
- 1.6 Latest version of the Codes, Standards, Specifications, etc. notified/published at least 60 days before the last date of bid submission shall be considered applicable.
- 1.7 The terms 'Ministry of Surface Transport', 'Ministry of Road Transport and Highways' and 'Ministry of Shipping, Road Transport & Highways' or any successor or substitute thereof shall be considered as synonymous.
- 1.8 The terms 'Inspector' and 'Engineer' used in MOSRTH Specifications shall be deemed to be substituted by the term "Independent Engineer" to the extent it is consistent with the provisions of the Concession Agreement and this Manual.
- 1.9 In case of any conflict or inconsistency with the provisions of the applicable IRC Codes, Standards or MOSRTH Specifications, the provisions contained in this Manual and the Specifications and Standards specified in this Manual shall apply.
- 1.10 In the absence of any specific provision on any particular issue in the aforesaid Codes or Specifications read in conjunction with the Specifications and Standards contained in this Manual, the following Standards shall apply in order of priority:
- (i) Bureau of Indian Standards (BIS)
 - (ii) British Standards, or American Association of State Highway and Transportation Officials (AASHTO) Standards, or American Society for Testing and Materials (ASTM) Standards
 - (iii) Any other specifications / standards proposed by the Concessionaire and reviewed by the IE.
- 1.11 All items of building works shall conform to State Public Works Department (State PWD)/Central Public Works Department (CPWD) Specifications for Class 1 building works and standards given in the National Building Code (NBC). To the extent, specific provisions for building works are made in IRC/MOSRTH/ State PWD specifications, the same shall prevail over the CPWD/NBC provisions. For this

purpose, building works shall be deemed to include toll plaza complex, road furniture, roadside facilities, landscape elements and/or any other works incidental to the building works.

1.12 Guidelines for Preparing Schedules of the Concession Agreement

Certain paras (full or part) in Sections 1 to 14 of this Manual refer to the Schedules of the Concession Agreement. While finalizing the feasibility/project report for the Project Highway, and the scope of the project, each of these paras should be carefully examined and addressed by the Government with a view to making appropriate provisions in the Schedules of the Concession Agreement. (A list of the paras that refer to such Schedules has been provided at Appendix-1 for ready reference).

1.13 Alternative Standards and Specifications

The requirements stated in the Manual for the design of the Project Highway are the minimum. The Concessionaire will, however, be free to adopt international practices, alternative specifications, materials and standards to bring in innovation in the design and construction provided they are comparable with the standards prescribed in the Manual. The Specifications and techniques which are not included in the MOSRTH Specifications/IRC Specifications/State PWD Specifications shall be supported with authentic standards and Specifications like AASHTO, Euro Codes, British Standards and Australian Code etc. Such a proposal shall be submitted by the Concessionaire to the Independent Engineer for review and comments, if any. In case, the Independent Engineer is of the opinion that the proposal submitted by the Concessionaire is not in conformity with any of the international standards or codes, then he will record his reasons and convey the same to the Concessionaire for compliance. A record shall be kept by the Independent Engineer, of the non-compliance by the Concessionaire of the minimum Specifications and Standards specified in the Manual and shall be dealt with in terms of the provisions of the Concession Agreement. The Concessionaire shall be responsible for adverse consequences, if any, arising from any such non-compliance.

1.14 Design Service Volume and Carriageway Provision

- (i) Where initial traffic is comparatively low, two-stage capacity augmentation may be opted and specified in Schedule-B of the Concession Agreement. In the first stage, Two-laning (without paved shoulders) may be undertaken and further

widening to Two-laning Plus (Two-lane carriageway with paved shoulders) undertaken in the second stage on the basis of the following criteria:

- (a) In case, the average daily traffic at the time of bidding is less than 8,000 PCUs in plain terrain or 6,500 PCUs in rolling terrain, initially 2-lane wide carriageway with granular shoulders may be provided as per Para 2.5.2(ii).
- (b) The carriageway may be widened by providing 1.5 m wide paved shoulders on either side when the average daily traffic exceeds 10,000 PCUs in plain terrain or 8,000 PCUs in rolling terrain on the basis of the twelve months' average in an accounting year. The paved shoulders shall be provided within six months from the close of the accounting year in which average daily traffic exceeds the specified value. The crust thickness and composition in the widened portions (paved shoulders) shall be the same as in the main carriageway. (Refer to para 5.9.9).
- (ii) In case the average daily traffic at the time of bidding is more than 10,000 PCUs in plain terrain or 8,000 PCUs in rolling terrain, widening to Two laning Plus (Two lane carriageway with paved shoulders) may be undertaken straightaway and specified in Schedule-B of the Concession Agreement.
- (iii) In case the average daily traffic at the time of bidding is in the range of 8,000 to 10,000 PCUs in plain terrain or 6,500 to 8,000 PCUs in rolling terrain, the Government will decide as to whether adopt two-stage capacity augmentation or prescribe Two-laning Plus straightaway and specify the same accordingly in Schedule-B of the Concession Agreement.
- (iv) The design service volume of a 2-lane highway is given in Table 2.8.

1.15 Before taking up any construction or maintenance operations like widening, strengthening, resurfacing, repairs etc., the Concessionaire shall first work out a plan to ensure the following:

- (i) Safety of traffic during the period of construction and the reduction of potential delays to road users.
- (ii) Safety of the workers engaged in construction.
- (iii) The arrangement for traffic during construction shall conform to the requirements of Clause 112 of MOSRTH Specifications. The Concessionaire shall furnish and

erect the barricades, traffic signs and markings, arrangements for adequate lighting, equipment and flagman etc. as required in accordance with IRC:SP:55.

The Concessionaire shall communicate the proposal for safety of traffic and workers during construction to the Independent Engineer for review and comments, if any.

- 1.16 The Concessionaire shall set up an adequately equipped field laboratory for testing of materials and finished products as prescribed in Clause 121 of MOSRTH Specifications. It shall make necessary arrangements for additional/confirmatory testing of any materials/products for which facilities at site laboratory are not available.

1.17 Review and comments by Independent Engineer

In cases where the Concessionaire is required to send any drawings or documents to the Independent Engineer for review and comments, and in the event such comments are received by the Concessionaire, it shall duly consider such comments in accordance with the Concession Agreement and Good Industry Practice for taking appropriate action thereon.

1.18 Definitions and Interpretation

- 1.18.1 All the obligations of the Concessionaire arising out of the provisions of this Manual shall be subject to, and shall conform to the provisions of the Concession Agreement.
- 1.18.2 The rules of interpretation as specified in Clause 1.2 of the MCA shall apply mutatis mutandis to this Manual.
- 1.18.3 The definitions contained in the Model Concession Agreement for Public Private Partnership in State Highways ("the MCA"), as published by the Planning Commission, Government of India shall apply to the provisions of this Manual unless the context otherwise requires. Terms or words not defined herein shall be governed by the definitions contained in the IRC Standards, unless the context otherwise requires.
- 1.19 This Manual is for Two-laning (with or without paved shoulders) of the Project Highway.



Section 2

**Geometric Design and
General Features**



SECTION 2

GEOMETRIC DESIGN AND GENERAL FEATURES

2.1 General

- (i) This Section lays down the standards for geometric design and general features for upgrading the existing state highways/major district roads to two-lane with or without paved shoulders.
- (ii)
 - (a) Stretches passing through built up areas shall normally be provided with 4-lane divided carriageway (Fig. 2.2). Such stretches shall be indicated in Schedule-B of the Concession Agreement. Additional land, if any, required for 4-laning shall be acquired by the Government and where the land is yet to be acquired, the date of handing over the land to the Concessionaire shall be indicated.
 - (b) Where there are constraints of existing ROW width or difficulty in acquiring land along the existing alignment in built up areas, the Government may specify construction of a bypass instead of 4-laning. The alignment of the bypass shall be specified by the Government. The land for the bypass shall be acquired by the Government and where the land is yet to be acquired, the date of handing over the land to the Concessionaire shall be indicated. The bypass shall be access controlled, unless specified otherwise. In case, the Government decides to provide two-lane carriageway for the bypass, the same shall be placed eccentrically with respect to the ROW to facilitate proper widening to four lanes in future.
- (iii) The geometric design of the Project Highway shall conform to the standards set out in this Section as a minimum. The Concessionaire shall ensure that liberal geometric standards are followed to the extent feasible within the given Right of Way.
- (iv) As far as possible, uniformity of design standards shall be maintained throughout the length. In case of any change, it shall be effected in a gradual manner.
- (v) Where the existing road geometrics are deficient with respect to minimum requirements and its improvement to the prescribed standards requires acquisition of additional land, such stretches shall be specified in Schedule-B of the Concession Agreement. Additional land as required shall be provided by the Government.

- (vi) Existing horizontal curves, which are found deficient in radius, layout, transition lengths or superelevation shall be corrected to the specified standards.
- (vii) Any deficiencies in the vertical profile in respect of grades, layout of vertical curves and sight distance shall be corrected to meet the minimum specified requirements.

2.2 Design Speed

2.2.1 The design speeds given in Table 2.1 shall be adopted for various terrain classifications (Terrain is classified by the general slope of the ground across the highway alignment).

Table 2.1 : Design Speed

| Nature of Terrain | Cross slope of the ground | Design speed (km/hr) | |
|-------------------|----------------------------|----------------------|---------|
| | | Ruling | Minimum |
| Plain | Less than 10 per cent | 100 | 80 |
| Rolling | Between 10 and 25 per cent | 80 | 65 |
| Mountainous | Between 25 and 60 per cent | 50 | 40 |
| Steep | More than 60 per cent | 40 | 30 |

- 2.2.2 Short stretches (say less than 1 km) of varying terrain met with on the road stretch shall not be taken into consideration while deciding the terrain classification for a given section of Project Highway.
- 2.2.3 In general, the ruling design speed shall be adopted for the various geometric design features of the road. Minimum design speed shall be adopted where site conditions are restrictive and adequate land width is not available. The Concessionaire shall improve the alignment as per the requirement for ruling design speed as and when the Government provides land. Such stretches shall be indicated in Schedule-B of the Concession Agreement. Land for such stretches shall be provided by the Government not later than five years from the date of commercial operation (COD). Abrupt changes in design speed shall be avoided.

2.3 Right of Way

The Right of Way (ROW) is the total land width required for the Project Highway, to accommodate the roadway (carriageway and shoulders), side drains, service roads, tree plantation, utilities, etc. The ROW available for the Project Highway shall be as given

in Schedule-A of the Concession Agreement. The Government should acquire additional land accordingly. The land to be so acquired shall be indicated in Annexure II of Schedule-A of the Concession Agreement. The desirable Right of Way for Non-urban & Urban areas should be as prescribed in IRC:73 & IRC:86 respectively.

2.4 Lane width of Carriageway

The standard lane width of the Project Highway shall be 3.5 m.

2.5 Shoulders

2.5.1 Width of Shoulders

The normal shoulder width shall be as under:

Table 2.2 : Width of Shoulder

| Type of Section | Width of Shoulder (m) | | |
|--|---------------------------|--------------------------------|-------------|
| | Plain and Rolling Terrain | Mountainous and Steep Terrain* | |
| | (Either side) | Hill side | Valley side |
| Open country with isolated built up area | 2.5 m | 1.0 m | 2.0 m |
| Built up area | 2.5 m | 1.0 m | 2.0 m |

**exclusive of parapets and side drains*

2.5.2 Type of Shoulder

The type of shoulder shall be as below:

- (i) In the built up section, the shoulder shall be fully paved or footpath shall be provided where specified in Schedule-B of the Concession Agreement.
- (ii) In open country with isolated built up area, and where average daily traffic is less than 8,000 PCUs in plain terrain or 6,500 PCUs in rolling terrain, the shoulder shall be covered with 150 mm thick layer of granular material conforming to the requirements given in para 5.9.10.
- (iii) In open country with isolated built up area and having plain or rolling terrain and where average daily traffic is greater than 10,000 PCUs in plain terrain

or 8,000 PCUs in rolling terrain, 1.5 m width adjacent to the carriageway shall be paved in accordance with para 5.9.9 of this Manual and balance 1.0 m shall be covered with 150 mm thick layer of granular material.

- (iv) In open country having mountainous/steep terrain, the shoulders shall be of locally available hard material.

2.6 Roadway Width

2.6.1 The width of roadway, unless specified otherwise, shall be as follows:

- Plain/Rolling Terrain – 12.0 m
- Mountainous and Steep Terrain – 10.0 m (exclusive of parapets and drains)

2.6.2 On horizontal curves with radius up to 300 m, width of pavement and roadway shall be increased as per Table 2.3.

Table 2.3 : Extra Width of Pavement and Roadway

| Radius of Curve | Extra Width |
|-----------------|-------------|
| Upto 40 m | 1.5 m |
| 41-60 m | 1.2 m |
| 61-100 m | 0.9 m |
| 101-300 m | 0.6 m |

2.7 Camber or Crossfall

2.7.1 The camber or crossfall on straight sections of road carriageway and shoulders shall be as per Table 2.4.

Table 2.4 : Camber/Crossfall in percentage for different Surface Types

| Category of surface | Annual Low rainfall (less than 1500 mm) | Annual High rainfall (more than 1500 mm) |
|---------------------|--|---|
| Bituminous | 2.5 % | 2.5 % |
| Cement Concrete | 2.0 % | 2.0 % |
| Metal/Gravel | 2.5 % | 3.0 % |
| Earth | 3.0 % | 4.0 % |

2.7.2 The two-lane roads shall be provided with a crown in the middle. On horizontal curves, the carriageway shall be superelevated.

2.7.3 The camber for earthen shoulders on straight portions shall be at least 0.5 per cent steeper than the slope of the pavement and paved shoulder subject to a minimum of 3.0 per cent. On super elevated sections, the shoulders shall have the same crossfall as the carriageway.

2.8 Horizontal Alignment

2.8.1 While designing the horizontal alignment, the following general principles shall be kept in view:

- (i) Alignment should be fluent and it should blend well with the surrounding topography.
- (ii) On new roads, the curves should be designed to have largest practical radius, but in no case less than ruling value corresponding to ruling design speed.
- (iii) As a normal rule, sharp curves should not be introduced at the end of long tangent since these can be extremely hazardous.
- (iv) The curves should be sufficiently long and they should have suitable transitions to provide pleasing appearance.
- (v) Reverse curves shall be avoided as far as possible. Where unavoidable, sufficient length between two curves shall be provided for introduction of requisite transition curves.
- (vi) Curves in the same direction, separated by short tangents known as broken back curves, should be avoided as far as possible.
- (vii) To avoid distortion in appearance, the horizontal alignment should be coordinated carefully with the longitudinal profile.
- (viii) Hairpin bends on hilly terrain should be avoided as far as possible.

2.8.2 All horizontal curves shall consist of circular portion flanked by spiral transitions at both ends.

2.8.3 *Superelevation*

- (i) Superelevation shall be provided on curves as per details given in IRC:73 corresponding to the design speed adopted.

- (ii) Superelevation shall be limited to 7 per cent.
- (iii) Superelevation shall not be less than the minimum specified cross fall/camber.

2.8.4 *Radii of Horizontal Curves*

The desirable minimum and absolute minimum radii of horizontal curves for various classes of terrain are given in Table 2.5.

Table 2.5 : Minimum Radii of Horizontal Curves

| Nature of terrain | Desirable minimum | Absolute minimum |
|-------------------|-------------------|------------------|
| Plain | 360 m | 230 m |
| Rolling | 230 m | 155 m |
| Mountainous | 90 m | 60 m |
| Steep | 60 m | 30 m |

The radius of horizontal curves for various terrain conditions shall not be less than the desirable values given in Table 2.5 except where site conditions are restrictive and adequate land is not available. Where such restrictions exist, the radius of curve shall not be less than the specified absolute minimum value.

2.8.5 *Transition Curves*

Minimum length of transition curve shall be determined from the following two considerations and the larger of the two values adopted for design:

- (i) The rate of change of centrifugal acceleration should not cause discomfort to drivers. From this consideration, the length of transition curve is given by:

$$L_s = 0.0215 V^3/CR,$$

Where:

L_s = Length of transition curve in metres,

V = Speed in km/hr,

R = Radius of circular curve in metres,

C = $80/(75 + V)$ (subject to a maximum of 0.8 and minimum of 0.5)

- (ii) The rate of change of superelevation should be such as not to cause discomfort to travelers. Further, rate of change should not be steeper than 1 in 150 for

roads in plain/rolling terrain, and 1 in 60 in mountainous/steep terrain. The formula for minimum length of transition on this basis is:

$$L_s = 2.7 V^2/R$$

2.9 Sight Distance

- 2.9.1 Visibility is an important requirement for the safety of travel on roads. For this, it is necessary that sight distance of adequate length is available in different situations, to permit drivers enough time and distance to control their vehicles so that chances of accidents are minimized.
- 2.9.2 On two-lane roads, normally intermediate sight distance should be available throughout. The attempt should, however, be to provide overtaking sight distance in as much length of the road as possible. In stretches where even intermediate sight distance is not available, the safe stopping sight distance should be provided as a last resort. Traffic signs depicting "Overtaking Prohibited:" shall be installed at all such locations.
- 2.9.3 The recommended sight distances for various speeds are given in Table 2.6.

Table 2.6 : Sight Distances for Various Speeds

| Speed (km/hr) | Stopping sight distance (m) | Intermediate sight distance (m) | Overtaking sight distance (m) |
|---------------|-----------------------------|---------------------------------|-------------------------------|
| 100 | 180 | 360 | 640 |
| 80 | 120 | 240 | 470 |
| 65 | 90 | 180 | 340 |
| 50 | 60 | 120 | 235 |
| 40 | 45 | 90 | 165 |
| 30 | 30 | 60 | 120 |

- 2.9.4 The requisite sight distance shall be available across the inner side of horizontal curves.
- 2.9.5 Where horizontal and summit curves overlap, the design shall provide for the required sight distance, both in the vertical direction, along the pavement and in the horizontal direction on the inner side of curve.

2.10 Vertical Alignment

2.10.1 The vertical alignment should provide for a smooth longitudinal profile. Grade changes should not be too frequent as to cause kinks and visual discontinuities in the profile. The ruling and limiting gradients are given in Table 2.7.

Table 2.7 : Recommended Gradients

| Nature of terrain | Ruling gradient | Limiting gradient |
|-------------------|-----------------|-------------------|
| Plain and rolling | 3.3% | 5.0% |
| Mountainous | 5.0% | 6.0% |
| Steep | 6.0% | 7.0% |

2.10.2 Gradients up to the value corresponding to ruling gradient shall be adopted, as far as possible. Limiting gradients shall be adopted only in very difficult situations and for short lengths.

2.10.3 Long sweeping vertical curves shall be provided at all grade changes. These shall be designed as square parabolas.

2.10.4 For design of vertical curves and its co-ordination with horizontal curves, reference may be made to IRC:SP:23.

2.11 Lateral and Vertical Clearance at Underpasses

Wherever a cross road is proposed to be taken below the Project Highway, minimum clearances at underpasses shall be as follows:

2.11.1 Lateral Clearance

- (i) Full roadway width at the approaches including service roads, if any, shall be carried through the underpass. Provision shall also be made for future expansion of the cross road for at least next 10 years.
- (ii) Guardrails shall be provided for protecting vehicles from colliding with the abutments/piers and the deck of the structures.

2.11.2 Vertical Clearance

Vertical clearance at underpasses shall not be less than the values given below:

- (i) Vehicular underpass 5.5 m
- (ii) Pedestrian and Cattle underpass 3.0 m

2.12 Lateral and Vertical Clearance at Overpasses

Wherever any structure crosses over the Project Highway, the minimum clearances at overpasses shall be as follows:

2.12.1 Lateral Clearance

Full roadway width including service roads, if any, shall be carried through the overpass structure. Provision shall also be made for future widening of the Project Highway. The abutments and piers shall be provided with suitable protection against collision of vehicles. Guardrails shall be provided on abutment side and on sides of piers for this purpose. The ends of guardrails shall be turned away from the line of approaching traffic.

2.12.2 Vertical Clearance

A minimum 5.5 m vertical clearance shall be provided from all points of the carriageway of the Project Highway to the nearest surface of the overpass structure.

2.13 Service Roads

2.13.1 Service roads wherever required to be constructed by the Concessionaire, shall be specified in Schedule-B of the Concession Agreement.

2.13.2 Service roads shall be constructed and maintained in accordance with the provisions of the Concession Agreement. The width of service roads shall be minimum 5.5 m.

2.13.3 The crust composition of service roads shall not be lower than that specified in IRC:37 for 1 (one) msa design traffic.

2.14 Grade separated Structures

2.14.1 The type, location, length, number and the openings required to be provided for various types of grade separated structures shall be as specified by the Government in Schedule-B of the Concession Agreement.

2.14.2 Vehicular Underpass/Overpass

The vehicular underpass/overpass structures shall be provided at the intersection of the Project Highway with all roads carrying an average daily traffic of more than 15,000 PCUs, unless specified otherwise. The structure may be either an underpass or an overpass depending upon the nature of terrain, vertical profile of road,

availability of adequate right of way, etc. Type of the structure shall be specified in Schedule-B of the Concession Agreement.

2.14.3 Cattle and Pedestrian Underpass/Overpass

- (i) In certain stretches, underpasses/overpasses for crossing of cattle and pedestrians shall be provided at locations indicated in Schedule-B of the Concession Agreement.
- (ii) The width of Pedestrian or Cattle crossing shall not be less than 5 m.
- (iii) The pedestrian crossings shall have provision for movement of disabled persons.

2.15 Typical Cross-Sections

2.15.1 Typical cross-sections of Project Highway are given in Figs. 2.1 to 2.5. These shall be adopted for various locations, as applicable.

2.15.2 Where cross-section changes from two-lane to four-lane, a transition of 1 in 15 to 1 in 20 must be provided, as prescribed in IRC:73 (Cl. 6.6.2) & IRC:86 (Cl. 6.2.7).

2.16 Capacity of two-lane highway

The design service volume of two-lane highway for different types of terrain shall be as given in Table 2.8.

Table 2.8 : Design Service Volume of Two-lane Highway in PCUs per day

| Nature of Terrain | Design Service Volume in PCUs per day | |
|-----------------------|---------------------------------------|-----------------------------------|
| | without paved shoulder | with minimum 1.5 m paved shoulder |
| Plain | 15,000 | 18,000 |
| Rolling | 11,000 | 13,000 |
| Mountainous and Steep | 7,000 | 9,000 |

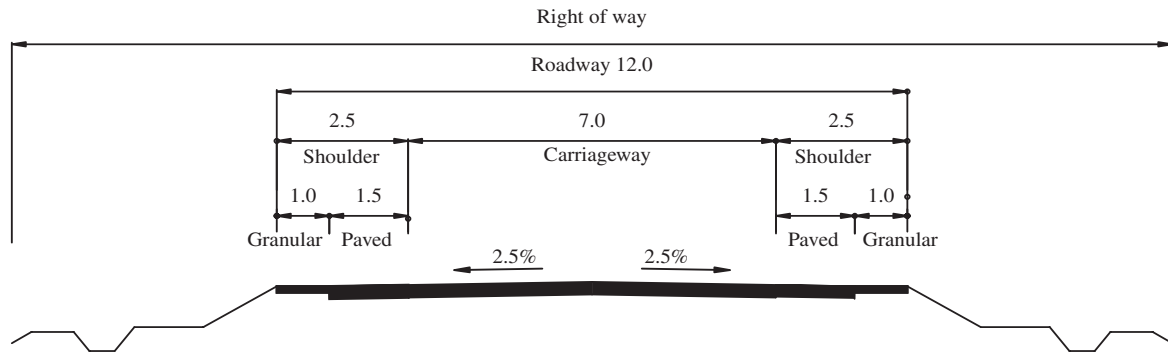

Note:
All dimensions are in metres.

Typical cross section
(Open country-plain/rolling terrain)
2-lane carriageway (with paved shoulders)
without service road

Fig. 2.1

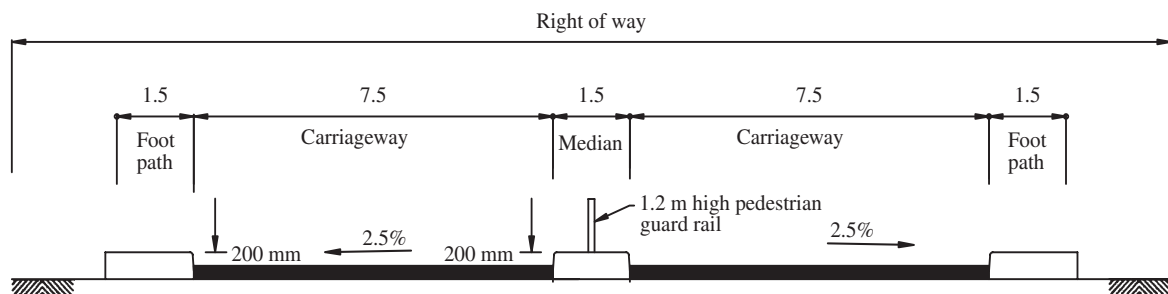

Note:
All dimensions are in metres
except as shown otherwise.

Typical cross section
(Built-up area)
4-lane divided carriageway with footpath

Fig. 2.2

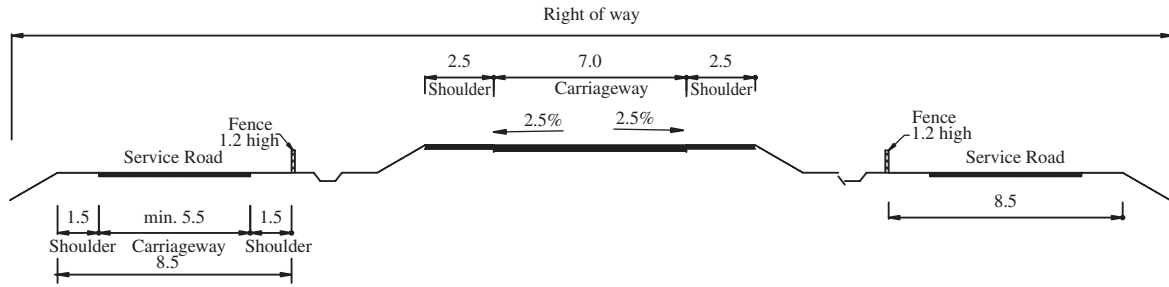

Note:

1. All dimensions are in metres.
2. Dimensions of footpath and service roads are minimum and higher may be adopted as per requirement.

**Typical cross section
2-lane carriageway with service road**

Fig. 2.3

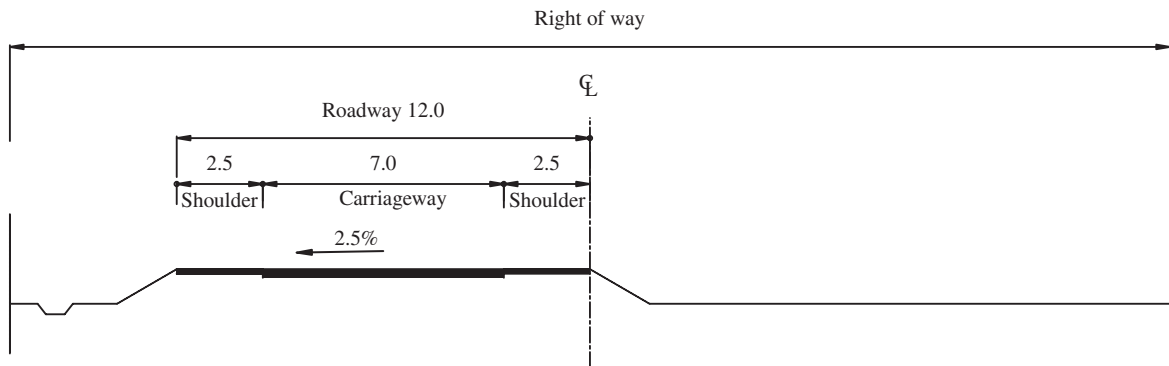

Note:

All dimensions are in metres.

**Typical cross section
(Plain/rolling terrain)
Eccentrically placed 2-lane bypass**

Fig. 2.4

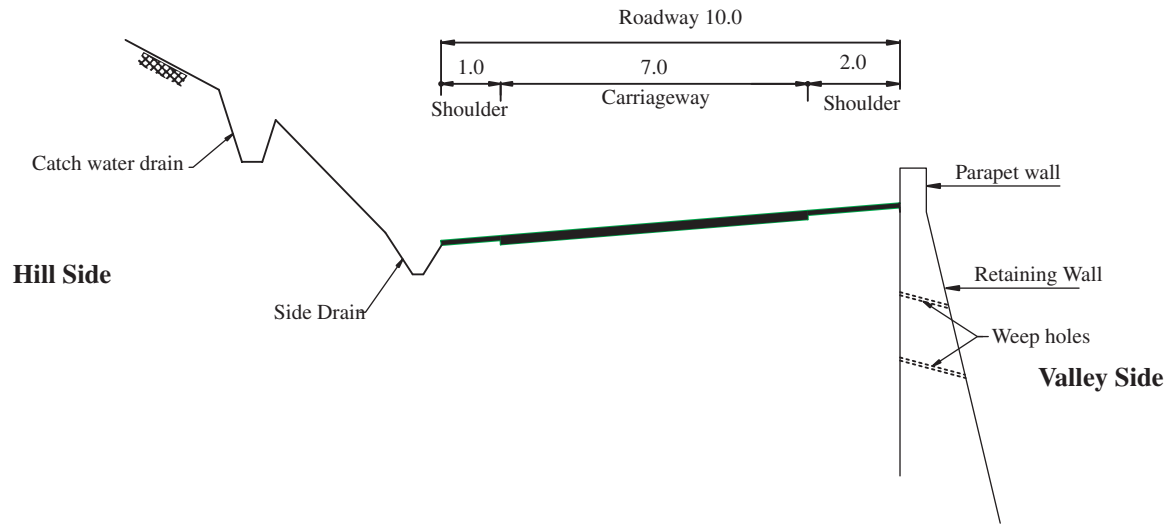

Note:

1. All dimensions are in metres.
2. Shoulders covered with locally available hard material (Paved shoulders in built up area).

**Typical cross section
(Mountainous terrain)
2-lane carriageway**

Fig. 2.5



Section 3

Intersections and Grade Separators



SECTION 3

INTERSECTIONS AND GRADE SEPARATORS

3.1 Introduction

3.1.1 Subject to the provisions of this Manual, properly designed intersections shall be provided at all road crossings/junctions. The types and locations of Interchanges and Grade-separated Intersections without ramps shall be specified in Schedule-B of the Concession Agreement. The intersections to be provided shall be one of the following types:

- (i) At-grade intersections
- (ii) Grade separated intersections without ramps
- (iii) Interchanges

3.1.2 The existing intersections, which are deficient with respect to the minimum requirements shall be improved to the prescribed standards. Additional land, if any, required for improving the existing intersections shall be provided by the Government.

3.2 At-grade Intersections

3.2.1 General

- (i) The majority of the intersections to be encountered will be of At-grade type. These are most economical and are provided at crossing locations, where the traffic on cross roads is low to moderate. These intersections should be properly designed as per details below.
- (ii) Type of intersections to be adopted shall be decided on the basis of parameters like number of intersecting legs, traffic volume/speed, available right of way, type of traffic control (signalized/non-signalized) etc. Necessary traffic surveys for the design of road junctions shall be carried out as per IRC:SP:19.
- (iii) Normally, the type of intersection shall be:
 - (a) Three leg intersection.
 - (b) Four leg intersection.
 - (c) Multi leg intersection/rotary.
- (iv) The design of different elements of intersection shall be done as per IRC:SP:41 including other design criteria given in the subsequent paras. MOSRTH - Type Designs for Intersection on National Highways, 1992 may also be referred to,

wherever required, to develop suitable lay out and design of At-grade Intersections.

- (v) The design shall aim at simplicity and uniformity in design standards. Complex designs which may involve complicated decision making by drivers shall be avoided.
- (vi) The intersection control shall be of 'Stop Control' unless specified otherwise. This will mean that traffic on the minor road must stop prior to entering the major road. Where roads of equal importance intersect, priority will be given to the traffic on the right.
- (vii) At the intersection, the alignment should be as straight and the gradient as flat as practicable. Gradients in excess of 2 per cent will normally not be allowed at intersections.
- (viii) Any deficiency in the alignment and grade of intersecting roads shall be corrected to improve traffic conditions and safety.
- (ix) The sight distance to be adopted shall normally be intermediate sight distance as specified in Section 2. However, in exceptional situations it should not be less than minimum stopping sight distance specified in Section 2. At such locations, cautionary speed limit signboards shall be displayed.
- (x) At multi leg intersections, the points of conflict should be studied carefully and possibilities of realigning one or more of the intersecting legs and combining some movements to reduce the conflicting movements shall be examined. The objective shall be to simplify the design and appropriate control devices added to ensure more efficient and safe operation.

3.2.2 *Design Standards*

Design standards shall be as per IRC:SP:41. Salient features are given below:

- (i) **Design Speed:** The approach speed shall be taken as the design speed adopted for the section of Project Highway on which the intersection is located. The design speed for various elements of the intersection shall be taken as 60% of the approach speed.
- (ii) **Design Traffic Volume:** The traffic volume for the design of intersection and its distribution at peak hours shall be assessed, up to the operation period, taking into consideration the past trend, likely new development of land, socio-economic changes, etc.

- (iii) Design Vehicle: Semi-trailer combination (refer IRC: 3) shall be used in the design of intersections.
- (iv) The number of lanes to be provided at the intersection shall be governed by peak hour traffic volume in each direction of travel. For single lane movements, a minimum width of 5.5 m is to be adopted. For two-lane roads between kerbs, a minimum 7.5 m width shall be provided. Widening of carriageway shall be achieved by a taper of not less than 1 in 15.
- (v) Type and radius of curve of intersection: The type and radii of curves would depend upon the types of vehicles turning at the intersection and shall be decided based on the traffic data.
- (vi) Visibility at intersection: A minimum safe stopping sight distance, appropriate for the approach speeds, shall be available for the traffic on the Project Highway.

3.2.3 *Traffic Control Devices*

- (i) Road markings: Typical road markings for road intersection as given in IRC:SP:41 and IRC:35 shall be followed. The specifications of road markings shall be as given in Section 9 of this Manual.
- (ii) Signs: Traffic signs at the junctions shall be provided as per IRC: 67 and Section 9 of this Manual.
- (iii) Reflectors: To guide the traffic, reflectors in the form of cat's eyes, delineators, etc shall be provided, in addition to the road markings, especially at the channelising islands.

3.2.4 *Detailed Designs and Data for Review by IE*

The Concessionaire shall submit the details of the ground surveys, traffic data, traffic forecast, design and drawings of the intersections showing all safety features to the Independent Engineer for review and comments, if any.

3.3 **Grade Separated Intersections Without Ramps**

3.3.1 *General*

- (i) Grade separated intersections, without ramps provide an intermediate solution (between At-grade Intersections and Interchanges) for traffic segregation. These are relatively cheaper as compared to Interchanges. These could preferably, be provided at locations where traffic on cross roads is moderate to heavy and

segregation though essential, cannot be provided by an Interchange due to cost constraints. Under this type, two cross roads separate at different grades (as Road Under Bridge or Road Over Bridge) and all turning movements for transfer of traffic between the intersecting roads including merging, diverging, etc. shall be either not catered to or shall be accomplished at surface level through parallel service roads or through similar other mechanism.

- (ii) Grade separated intersections without ramps shall be provided at the locations indicated in Schedule-B of the Concession Agreement. The road to be carried over or under the structures shall be specified in Schedule-B of the Concession Agreement.
- (iii) All features pertaining to structures for this type of grade separator will be same as provided in Section 2 of this Manual.

3.3.2 *Geometric Standards for Design of Various Elements*

The geometric design standards for various elements of this type of grade separators shall be as given in paras 3.2.1 and 3.2.2.

3.3.3 *Design of Structures*

For design of structures of grade-separated structures, the details given in Sections 7 and 8 of this Manual shall be followed. Minimum length of viaduct required to be provided at various grade separated structures shall be specified by the Government in Schedule-B of the Concession Agreement.

3.3.4 *Traffic Control Devices*

Details given in paras 3.2.3 and 3.4.6 shall apply.

3.3.5 *Detailed Design and Data for Review by IE*

The Concessionaire shall submit the details of the ground surveys, traffic data, traffic forecast, design and drawings of the grade separated intersections and the structures, showing all safety features, to the Independent Engineer for review and comments, if any.

3.4 **Interchanges**

3.4.1 *General*

- (i) An Interchange is a grade-separated intersection with connecting roadways

(ramps) for turning traffic between highway approaches. Such an Interchange will be necessary at all crossings of a highway, which is to be developed to completely access controlled standards. An Interchange may also be justified at locations where traffic on cross roads is heavy and when an At-grade intersection fails to handle the heavy volume of turning, merging and diverging traffic leading to excessive delays and fatal and major accidents. Cost effectiveness will decide whether to provide full Interchange or grade separated intersection without ramps.

- (ii) An Interchange may be justified at the crossing of the Project Highway with another highway, and where the total traffic on all the arms of the intersection is in excess of 10,000 PCUs in peak hour.
- (iii) The decision to provide Interchange at such locations shall be taken by the Government and the requirement shall be clearly spelt out in Schedule-B of the Concession Agreement, which shall also indicate specifications and traffic streams to be grade separated.
- (iv) The detailed design and layout of the Interchange shall conform to broad parameters and requirements specified by the Government in Schedule-B of the Concession Agreement. Based on detailed survey and investigations, the Concessionaire shall develop appropriate detailed drawings and designs and submit to the Independent Engineer for review and comments, if any.

3.4.2 *Types of Interchanges*

- (i) Interchanges are generally described by the pattern of the various turning roadways or ramps, which determine their geometric configuration. The common geometric configurations of Interchanges are the trumpet, diamond, cloverleaf, rotary and directional. Within each type of Interchange, there can be several variations such as split diamond, partial cloverleaf, etc. depending on the ramp arrangements.
- (ii) The type of Interchange, the shape and pattern of the Interchange ramps and loops and their designs shall be governed by factors such as the importance of the intersecting highway, the number of intersecting legs, the design volumes of through and turning traffic movements including their composition, the design speeds, available right of way and topography. The Interchange site shall be studied in detail and alternative designs made, to determine the most suitable arrangement of structures and ramps satisfying the specified requirements.

3.4.3 *Geometric Design Standards for Interchange Elements*

The geometric design standards shall be as per IRC: 92 appropriate for the design speed adopted for the Project Highway. The design speed for ramps shall not be less than 40 km per hour. The desirable values of various parameters given in IRC: 92 shall be adopted, unless there are severe site constraints.

3.4.4 *Design Traffic*

The traffic volume for the design of various elements of Interchange including ramps shall be assessed up to the end of the Concession Period or twenty years, whichever is more, taking into consideration the past trends, likely new development of land, socio-economic changes, etc.

3.4.5 *Design of Structure*

For design of structures of grade-separated structures comprising of main structure and ramps, the details given in Sections 7 and 8 of this Manual shall be followed. Minimum length of viaduct required to be provided at various grade-separated structures shall be specified by the Government in Schedule-B of the Concession Agreement.

3.4.6 *Traffic Control Devices*

Traffic signs (refer IRC: 67) shall be provided at suitable locations to:

- (i) Serve as advance notice of the approaches to the Interchange;
- (ii) Direct drivers into appropriate lanes for diverging/merging movements;
- (iii) Identify routes and directions;
- (iv) Provide other information of importance to the drivers; and
- (v) Show distances to destinations.

The specifications of road markings shall be as given in IRC:35 and as prescribed in Section 9 of this Manual.

3.4.7 *Detailed Design and Data for Review by IE*

The Concessionaire shall submit details of the ground surveys, traffic data, traffic forecast, design and drawings of the Interchange, showing all safety features, to the Independent Engineer for review and comments, if any.

Section 4
Road Embankment



SECTION 4

ROAD EMBANKMENT

4.1 General

- 4.1.1 The design and construction of road embankment and cuttings shall meet the requirements, standards and specifications given in this Section. This Section also covers specifications for subgrade and earthen shoulders.
- 4.1.2 Where the Project Highway involves improvement to an existing road, efforts should be made to remove the inherent deficiencies in plan, profile and the roadway width. It shall be ensured that the final centre line of the road and the road levels are fixed with great care, duly considering all the relevant factors covering structural soundness, safety and functional requirements.
- 4.1.3 The existing roadway, where deficient, shall be widened to the roadway width in accordance with para 2.6.

4.2 Road Embankment

- 4.2.1 The width of the embankment shall be in accordance with the cross-sectional details specified in Section 2 of this Manual.
- 4.2.2 The height of the embankment shall be based on the final road levels. The following principles shall be kept in view while fixing the road level:
- (i) For Improvement/Widening of the existing road;
 - (a) In case, bottom of the existing subgrade is 0.6 m above the HFL, the existing height of embankment can be retained.
 - (b) In case, it is less, then the bottom of subgrade should be raised to ensure a minimum 1 m clearance of the bottom of the subgrade from HFL. If raising of any section (s) of the Project Highway is required, that shall be specified in Schedule-B of the Concession Agreement.
 - (c) In case, Project Highway is passing through an area not affected by floods and is free from any drainage problem/water ponding/over-topping situations with water table being quite deep, to the extent that subgrade is not likely to be affected by the capillary saturation, then the employer may avoid raising in larger stretches to save cost, even though the minimum clearance of 0.6 m from existing ground level is desirable.

- (ii) New two lane road;
 - (a) Bottom of subgrade is 1.0 m above the high flood level/highest water table/ponded water level. The HFL should be decided by intelligent inspections, local observations, enquiries and studying the past records.
 - (b) Portions forming approaches to structures provide smooth vertical profile and fulfil the minimum free board requirement.
- 4.2.3 Portions forming approaches to structures provide smooth vertical profile.
- 4.2.4 Deficiencies in the existing vertical profile of the road shall be corrected.
- 4.2.5 Construction of embankment, subgrade and earthen shoulders shall conform to the requirements of Clause 305 of MOSRTH Specifications as a minimum requirement.
- 4.2.6 *Materials and Physical Requirements*
- 4.2.6.1 Sourcing of materials for embankment and subgrade construction, as well as compliance with environmental requirements in respect of excavation and borrow areas under the applicable laws shall be the sole responsibility of the Concessionaire.
- 4.2.6.2 Borrow pits shall not be located within the right of way or along the road. Clause 305.2.2 of MOSRTH Specifications shall apply.
- 4.2.6.3 The materials used in embankment, subgrade and earthen shoulders shall be soil, moorum, gravel, a mixture of these or any other material conforming to the requirements of Clause 305.2 of MOSRTH Specifications. Pond ash can also be used subject to requirement indicated in para 4.2.16 of this Section.
- 4.2.6.4 The following types of materials shall be considered unsuitable for embankment construction and shall not be used:
- (i) Materials from swamps, marshes and bogs;
 - (ii) Peat, log, stump and perishable material, any soil that is classified as OL, OI, OH in accordance with IS: 1498;
 - (iii) Materials susceptible to spontaneous combustion;
 - (iv) Materials in frozen conditions;
 - (v) Clay having Liquid Limit (LL) exceeding 70 and Plasticity Index (PI) exceeding 45;

- (vi) Materials with salt resulting in leaching in the embankment;
- (vii) Expansive clays, 'Free Swelling Index' (FSI) exceeding 50% when tested as per IS: 2720 (Part 40).

- 4.2.6.5 Expansive clays/black cotton soil shall not be used for subgrade construction.
- 4.2.6.6 Where expansive clay with acceptable Free Swelling Index value is used as a fill material, subgrade and top 500 mm portion of the embankment just below subgrade shall be non-expansive in nature.
- 4.2.6.7 The size of the coarse material in the mixture of earth shall not exceed 75 mm when placed in the embankment and 50 mm when placed in the subgrade.
- 4.2.6.8 Only the materials satisfying the density requirements given in Table 4.1 shall be employed for the construction of the embankment and the subgrade.

Table 4.1 : Density of Materials of Embankment and Subgrade

| Type of Work | Maximum Dry Density with heavy Compaction – IS: 2720 (Part 8) |
|--|--|
| Embankment upto 3 m height, not subjected to extensive flooding. | Not less than 15.2 kN/cu. m |
| Embankments exceeding 3 m height or embankments of any height subject to long periods of inundation. | Not less than 16.0 kN/cu. m |
| Subgrade and earthen shoulders/ verges/backfill. | Not less than 17.5 kN/cu. m |

- 4.2.6.9 The density requirements specified in Table 4.1 shall not be applicable to light weight material e.g. pond ash.
- 4.2.6.10 The material to be used, in subgrade shall satisfy the design CBR at the specified density and moisture content.
- 4.2.6.11 The embankment and subgrade shall be compacted to satisfy the minimum compaction requirements given in Table 4.2.

Table 4.2 : Compaction of Embankment and Subgrade

| Type of Work/Material | Relative Compaction as percentage of max. laboratory dry density - IS:2720 (Part 8) |
|--|--|
| Subgrade and earthen shoulders | Not less than 97 |
| Embankment | Not less than 95 |
| Expansive Clays (of acceptable FSI) | |
| (a) Subgrade and 500 mm portion just below the subgrade. | Not allowed |
| (b) Remaining portion of Embankment | Not less than 90 |

4.2.7 *Structural Features and Design of Embankment*

- 4.2.7.1 Embankment shall be designed to ensure the stability of the roadway and shall incorporate only those materials, which are suitable for embankment construction as per para 4.2.6 of this Section.
- 4.2.7.2 The design of side slopes shall be governed by slope stability and traffic safety considerations.
- 4.2.7.3 Side slopes shall not be steeper than 2H: 1V unless soil is retained by suitable soil retaining structures. The reinforced earth where provided, shall conform to the requirements of Section 7 of this Manual.
- 4.2.7.4 The type of retaining structure shall be aesthetically pleasing and compatible with the adjoining structures.
- 4.2.7.5 Where the embankment is to be supported on a weak stratum, it shall be necessary to carry out adequate soil testing and to specially design the embankment and also adopt appropriate remedial / ground improvement measures in consultation with the Independent Engineer.
- 4.2.7.6 Where the embankment is more than 3 m high and fill material consists of heavy clay or any problematic soil, the embankment stability shall be analysed and ascertained for safe design.
- 4.2.7.7 High embankments (height 6 m or above) in all soils shall be designed from stability considerations.

- 4.2.7.8 For design of high embankments IRC:75 may be referred to.
- 4.2.7.9 The side slopes shall be protected against erosion by providing a suitable vegetative cover, kerbs channel, chute, stone pitching/cement concrete block pitching or any other suitable protection measures, depending on the height of the embankment and susceptibility of soil to erosion. Drainage arrangement shall be provided as per Section 6 of this Manual.
- 4.2.7.10 Stone pitching/cement concrete block pitching shall conform to Clause 2504 of MOSRTH Specifications.
- 4.2.8 *Embankment Construction Operations*
- 4.2.8.1 Embankment, subgrade and earthen shoulders shall be constructed in accordance with Clause 305.3 of MOSRTH Specifications.
- 4.2.8.2 Any unsuitable material occurring in the embankment foundation shall be removed and replaced by acceptable fill material in accordance with Clause 305.3.4 of MOSRTH Specifications.
- 4.2.8.3 Where construction of embankment and subgrade is required to be carried out under the special conditions such as given in paras 4.2.7 to 4.2.13, the earthwork shall be done in accordance with the procedure and requirements described in Clause 305.4 of MOSRTH Specifications.
- 4.2.9 *Earthwork for Widening Existing Road*
- Where an existing embankment/subgrade is to be widened and its slopes are steeper than 1V: 4H, continuous horizontal benches each at least 300 mm wide shall be cut into the old slope for each lift of earthwork, for ensuring adequate bond with the fresh material to be added.
- 4.2.10 *Earthwork for Embankment and Subgrade to be Placed Against Sloping Ground*
- Requirements of Clause 305.4.2 of MOSRTH Specifications shall apply.
- 4.2.11 *Earthwork over Existing Road Surface*
- Requirements of Clause 305.4.3 of MOSRTH Specifications shall apply.
- 4.2.12 *Embankment and Subgrade around Structures*
- (i) The work shall be carried out in accordance with the requirements of Clause 305.4.4 of MOSRTH Specifications.

- (ii) Filling behind abutments, retaining walls, head walls and wing walls for structures shall conform to the general guidelines given in Appendix 6 of IRC:78.
- (iii) The filter medium shall conform to the requirements of Clause 2504 of MOSRTH Specifications.

4.2.13 *Construction of Embankment on Ground Incapable of Supporting Construction Equipment*

For construction of embankment on ground, which is not capable of supporting construction equipment such as marshy land, any of the methods given in Clause 305.4.5 of MOSRTH Specifications may be used.

4.2.14 *Embankment Construction Under Water*

Where construction of embankment is required to be done under water, only granular material or rock consisting of graded hard and durable particles with maximum size not exceeding 75 mm shall be used. The material shall be non-plastic with uniformity coefficient of not less than 10. For further details refer IRC:34.

4.2.15 *Earthwork for High Embankment*

Where stage construction/controlled rate of filling is required for high embankments, the methodology together with details of necessary instrumentation and monitoring plan shall be communicated by the Concessionaire to the Independent Engineer for review and comments, if any.

4.2.16 *Use of Pond Ash for Embankment Construction*

4.2.16.1 Where Pond ash is used for embankment construction in pursuance of the instructions of the Ministry of Environment and Forests or otherwise, the embankment shall be designed and constructed in accordance with IRC:SP:58.

4.2.16.2 The thickness of soil cover shall not be less than 1 m for embankments up to 3m high. For high embankments, the thickness of soil cover shall be increased as per design.

4.2.16.3 The side slopes of the embankment shall be protected against erosion by providing turfing or stone/cc block pitching.

4.2.17 *Surface Finish and Quality Control of Work*

The surface finish and quality control of materials and works shall conform to the requirements of Clauses 902 and 903 of MOSRTH Specifications and Para 5 of IRC:SP:58 (relevant to Pond ash).

4.3 **Roadway in Cutting**

4.3.1 The width of the roadway in cutting shall be in accordance with the cross section details specified in Section 2 of this Manual.

4.3.2 The road level shall be fixed, keeping in view the following requirement:-

The difference between the bottom of subgrade and the highest water table is not less than 1.0 m. Exceptionally, where this requirement is not satisfied, drain shall be provided to lower down the water table.

4.3.3 *Soil Investigations for Cut Sections*

- (i) Soil investigations shall be carried out to ascertain the type of cutting involved and in-situ soil conditions at the subgrade level. Reference may be made to IRC:SP:19.
- (ii) The side slopes of cuttings shall be provided in accordance with the nature of the soil encountered. The slope shall be stable for the type of strata. Where required, benching including use of slope stability measures like pitching, breast walls, etc. shall be adopted to make the slopes stable and safe.
- (iii) In the case of rock cutting, trial pits or boreholes shall be carried out at 30-50 m intervals to assess the type of rock.

4.3.4 Excavation for roadway in soil/rock shall be carried out in accordance with Clauses 301, 302 and 303 of MOSRTH Specifications, as relevant.

While executing excavation, adequate precautions against soil erosion, water pollution shall be taken as per Clause 306 of MOSRTH Specifications.

Appropriate drainage measures shall be taken to keep the site free of water in accordance with Clause 311 of MOSRTH Specifications.

No back filling shall be resorted to obtain the required slopes.

Adequate precautions shall be taken to ensure that during construction, the slopes are not rendered unstable or give rise to recurrent slides after construction.

In cut sections in hilly terrain, the problem of seepage flow is common. Where such conditions exist, necessary measures including provision of deep side drains to intercept the seepage flow and to avoid any damage to road and cut slopes shall be provided.

4.3.5 *Excavation of Road Shoulders for Widening of Pavement*

For widening of existing pavements or providing paved shoulders, the existing shoulders shall be removed to their full width and to the requisite depth. Care shall be taken to see that no portion of the existing pavement designated for retention is loosened or disturbed.

4.3.6 *Preparation of Cut Formation*

- (i) The cut formation, which serves as a subgrade, shall be prepared as per Clause 301.6 of MOSRTH Specifications.
- (ii) Where the material in the subgrade has a density less than that specified in Table 4.1, the same shall be loosened to a depth of 500 mm and compacted in layers in accordance with the requirements of Clause 305 of MOSRTH Specifications.
- (iii) Any unsuitable material encountered in the subgrade shall be removed and replaced with suitable material and compacted in accordance with Clause 305 of MOSRTH Specifications.

4.3.7 *Finishing Operations*

- (i) All excavated surfaces shall be properly shaped and dressed.
- (ii) No point on the completed slopes shall vary from the designated slopes by more than 150 mm (in case of soils) and 300 mm (in case of rocks) measured at right angle to the line of slope.
- (iii) The finished cut formation shall satisfy the surface tolerances specified in Clause 902 of MOSRTH Specifications.

4.4 **Soil Survey Investigations and Design Report**

The Concessionaire shall carry out necessary soil surveys and field and laboratory investigations for selecting appropriate borrow pits, identifying problematic ground locations if any, requiring treatment and for finalizing structural features and design of the embankment and cut sections. The soil survey and investigations report and design report shall be submitted to the Independent Engineer for review, if any.

4.4.1 *Soil Survey and Investigations Report*

The report shall include:

- (i) Road Embankment
 - (a) The report shall include soil investigations and tests in accordance with the requirements specified in IRC:SP:19 and shall be reported in the Proforma given in Table 1 of IRC:SP:19. In addition to this, all tests as per the requirements of MOSRTH Specifications shall be reported.
 - (b) In respect of high embankment, the report shall include additional investigations and soil tests as per IRC:75 and Appendix 10 of IRC:SP: 19.
 - (c) Information regarding the topography, high flood level, natural drainage conditions, highest sub-soil water level, and the nature and extent of inundation, if any.
 - (d) The characteristics of embankment foundation including the presence of any unsuitable/weak strata, marshy areas, water logged areas, etc.
 - (e) Along the alignment of the road, where unstable strata, soft material or poor subsoil conditions have been met with at the foundation level, the soil profile shall be drawn after determining through borings, the type of soil at different levels. The boring shall be at intervals of 100 to 200 m to a depth of 2 m below the existing ground. In the case of high embankments, the borings shall be taken down to a depth equal to twice the height of the embankment.
 - (f) Any particular construction problems of the area or other important features.
 - (g) Geotechnical properties of Pond ash, covering parameters specified in Table 1 of IRC:SP:58 and OMC-dry density relationship for heavy compaction. This information shall be furnished, in case Pond ash is used in embankment construction.

- (ii) Cut Sections

The report shall include soil investigations and tests in accordance with the requirements specified in IRC:SP:19 and information regarding depth of water table, seepage flow, presence of any weak, unstable or problematic strata.

4.4.2 *Design Report*

The Concessionaire shall furnish the design report including the following to the Independent Engineer for review and comments, if any.

- (i) Road Embankment
 - (a) The detailed design of the embankment, remedial/ground improvement treatment where required, and construction methodology for high embankments.
 - (b) Design of retaining walls/reinforced earth structures.
 - (c) Design of protection measures for embankment slope and drainage arrangement.
 - (d) Design of Pond ash embankment in case use of Pond ash is proposed.
 - (e) Any additional information relevant to the design report.
- (ii) Cut Section
 - (a) Type of cutting involved and proposed cut slopes.
 - (b) Design and details of erosion control, slope protection measures, etc.
 - (c) Design and details of drainage arrangement for sub-soil and surface water.
 - (d) Any other additional information relevant to the design of cut slopes.

Section 5

Pavement Design



SECTION 5

PAVEMENT DESIGN

5.1 General

- 5.1.1 The existing roads in the States are generally flexible pavements and their capacity augmentation by way of widening and strengthening would therefore generally be by provision of flexible pavements only.
- 5.1.2 Situations may, however, also arise where the Government may require provision of cement concrete pavement depending upon specific site conditions. Such a requirement shall be specified in Schedule-B of the Concession Agreement and indicated as a deviation in Schedule-D of the Concession Agreement. The minimum design and maintenance requirements for cement concrete pavement shall be specified by the Government and Schedule-K of the Concession Agreement shall be modified accordingly.
- 5.1.3 Design of new pavement sections or widening and strengthening of existing pavements shall take into account all relevant factors for assuring reliable performance that satisfies the specified minimum performance requirements.
- 5.1.4 The pavement condition and other data furnished by the Government are based on preliminary investigations. The Concessionaire shall undertake the necessary soil, material and pavement investigations and traffic volume and axle load studies in accordance with the good industry practice for preparing detailed designs.
- 5.1.5 The materials, mixes and construction practice shall meet the requirements prescribed herein and MOSRTH Specifications / IRC Specifications, unless specified otherwise.
- 5.1.6 Where problematic conditions such as expansive soils, swamps or marshes, flooding, poor drainage, etc. are found to exist, adequate measures shall be adopted to deal with such site conditions.

5.2 Method of Design of Flexible Pavement

The design of flexible pavement is covered in two parts namely, new pavements, and widening and strengthening of existing pavements. New pavements shall be designed in accordance with the method prescribed in IRC:37 or any other international standard method/guideline for pavement design, subject to the condition that the overall pavement composition shall not be less than the minimum requirement

specified in IRC:37. Strengthening of existing pavements shall be designed on the basis of the procedure outlined in IRC:81, except where specified otherwise.

5.3 Method of Design of Rigid Pavement

Rigid pavement shall be designed for a period of not less than 30 years, in accordance with the method prescribed in IRC:58.

5.4 Design of New Pavements

5.4.1 Flexible Pavement - Design Period and Strategy

- (i) Pavement shall be designed for a minimum design period of 15 years. Stage construction shall be permissible subject to the requirement specified in para (ii) below.
- (ii) Alternative strategies or combination of initial design, strengthening and maintenance can be developed by the Concessionaire to provide the specified level of pavement performance over the operation period, subject to satisfying the following minimum design requirements;
 - (a) The thickness of sub-base and base of pavement section is designed for a minimum design period of 15 years and the initial bituminous surfacing for a minimum design period of 8 years.
 - (b) The pavement shall be strengthened by bituminous overlay, as and when required, to extend the pavement life to full operation period. Strengthening in stages for not less than five years at a time can be done. The thickness of bituminous overlay shall be determined on the basis of IRC:81.

5.4.2 Rigid Pavement - Design Period and Strategy

- (i) The stage construction shall not be permitted in case of rigid pavement. The pavement shall be constructed in 10 m width (7 m carriageway plus 2X1.5 m rigid shoulders).
- (ii) The Pavement Quality Concrete (PQC) shall be designed as per para 5.3.1, based on a flexural strength of 4.5 MPa. The PQC shall rest over Dry Lean Concrete (DLC) sub-base of 150 mm thickness.
- (iii) The DLC will be of M10 concrete (7 days' strength) as prescribed in IRC:SP:49. DLC will be extending beyond the PQC (including that in shoulder, if any) by 1m on either side.

- (iv) A properly designed drainage layer (GSB) of thickness 150-200 mm shall be provided. The drainage layer shall be properly designed so that a drainage coefficient of 20 m per day is obtained.
- (v) The construction of rigid pavement should normally be done by Slip-form Paver. Stringent quality control is absolutely essential for long term performance of the rigid pavement and therefore, the same should be executed with utmost quality control and as per procedure laid down in IRC:15.
- (vi) The details of axle load surveys, for trucks only, shall be used in computing stress ratios as per IRC:58.

5.4.3 Pavement Performance Requirements

- i) The pavement structure shall be capable of giving the specified performance over the entire operation period.
- ii) The new pavement surface shall satisfy the following standards:
 - a. Roughness

| | |
|---|--|
| In each lane measured by calibrated BI | Not more than 2000 mm/km for each lane in a km length |
|---|--|
 - b. Rutting, cracking or any
other distress Nil
- (iii) During the operation period, the pavement surface roughness or any structural/functional distress shall not exceed the values specified in Schedule-K of the Concession Agreement. Any treatment in the form of renewal/overlay carried out or required to restore/correct/improve the riding quality or any distress shall be of such thickness and specification that will restore the riding quality to 2000 mm/km.

5.5 Design Traffic

- 5.5.1 The design traffic shall be estimated in terms of cumulative number of standard axles (8160 kg) to be carried by the pavement during the design period.
- 5.5.2 Estimate of the initial daily average traffic flow shall be based on atleast 7 days', 24 hour classified traffic counts. IRC:9 may be used as guidance for carrying out the traffic census.
- 5.5.3 Any likely change in traffic due to proposed improvement of the facility and/or future development plans, land use, shall be duly considered in estimating the design traffic.

- 5.5.4 Traffic growth rate shall be established for each category of commercial vehicles to be considered for design of pavement. For traffic projections, the procedure outlined in IRC:108 may be followed. The Concessionaire shall adopt a realistic value of the rate of traffic growth, provided that annual rate of growth of commercial vehicles shall not be assumed as less than 5 per cent.
- 5.5.5 Axle load surveys shall be carried out to estimate the vehicle damage factor (VDF) for each category of commercial vehicles. The axle load equivalency factors recommended in Annexure-2 of IRC:37 shall be used for converting different axle load repetitions into equivalent standard axle load repetitions. VDF values so determined shall be used for estimating design traffic in standard axles. Provided that if the Concessionaire envisages the possibility of controlling the severity and incidence of overloading with better enforcement of legal load limits as also of increase in the proportion of Multi Axle Vehicles over the years, it may, at its own risk and cost adopt a lower VDF value than that determined on the basis of the Axle load spectrum survey.
- 5.5.6 Lane distribution factors given in IRC:37 shall be adopted.
- 5.5.7 For rigid pavements Equivalent Damage Ratio (EDR) shall be adopted as given in IRC:58.

5.6 Subgrade

The subgrade, whether in cut or fill, shall meet the following requirements:

- (i) Subgrade material shall conform to the requirements laid down in Section 4. Expansive clays and other unsuitable soils shall not be used for subgrade construction. The material used in subgrade shall have dry density of not less than 17.5 kN/cu.m.
- (ii) The thickness of subgrade shall not be less than 500 mm.
- (iii) The subgrade shall be compacted to at least 97% of the maximum dry density achieved with heavy compaction in accordance with IS: 2720 (Part 8).
- (iv) The soaked CBR value of remoulded subgrade soil samples at the specified dry density and moisture content shall not be less than 7% (average of at least 3 specimens), unless specified otherwise.

5.7 Pavement Components and Materials

- (i) The pavement construction materials for sub-base, base and bituminous

surfacing shall conform to the requirements prescribed herein and the MOSRTH / IRC Specifications, unless specified otherwise.

- (ii) Where several materials will adequately serve as component within the pavement structure, such as a sub-base or a base course, the Concessionaire shall have the option of using any of the materials/specifications. It is important that good engineering practice and product quality requirements are not abandoned for the sake of effecting cost reduction.

If any material which is not specified here or included in MOSRTH / IRC / PWD Specifications is proposed to be used, the proposal supported with authentic standards and practice shall be communicated to the Independent Engineer for review and comments, if any.

5.7.1 *Sub-base*

- (i) Sub-base shall be of any of the following types:
 - (a) Granular sub-base conforming to clause 401 of MOSRTH Specifications. Sub-base material shall have minimum soaked CBR value of 30%.
 - (b) Cement treated soil sub-base conforming to clause 403 of MOSRTH Specifications.
 - (c) Water Bound Macadam conforming to IRC:19.
 - (d) Wet Mix Macadam conforming to IRC:109.
- (ii) Frost susceptible materials shall not be used in the sub-base.
- (iii) From pavement drainage considerations, the granular sub-base should be extended over the entire formation width. The granular sub-base shall be of proper design and grading to perform satisfactorily as the drainage layer. In cuttings, granular sub-base shall be at least 300 mm above the invert level of the drain.
- (iv) Where modification of granular sub-base grading given in Clause 401 of MOSRTH Specifications is considered necessary to improve its drainage properties, the PI, Compaction and Strength criteria shall be fully satisfied, besides drainage efficacy. Further where required, depending upon the gradation of the sub-base material and subgrade soil, an appropriate filter layer of soil/ aggregate or geo-textile shall be incorporated between the sub-base and the subgrade to prevent clogging of sub-base. The proposal shall be communicated to the Independent Engineer for review and comments, if any.

5.7.2 *Base Course*

- (i) Base course material and construction shall conform to any of the following types:
 - (a) Water Bound Macadam for base course conforming to IRC:19.
 - (b) Wet Mix Macadam for base course conforming to IRC:109.
 - (c) Crusher Run Macadam Base conforming to the requirements of Clause 410 of MOSRTH Specifications.
 - (d) Any other superior base material like Bituminous Macadam conforming to Clause 504 of MOSRTH Specifications can be used in combination with the granular base.
- (ii) The granular base shall be primed with a prime coat of low viscosity liquid bituminous material of appropriate type conforming to MOSRTH Specifications/ BIS specifications, preparatory to the superimposition of bituminous treatment or mix.

5.7.3 *Bituminous Surfacing*

- (i) The bituminous surfacing shall be either a wearing course or a binder course with a wearing course depending upon the design traffic.
- (ii) Bituminous surfacing materials and thicknesses shall satisfy the requirements of the IRC:37. The suggested surfacing materials and thickness are desirable minimum from functional and structural requirements.
- (iii) The specifications for the bituminous materials and mixes shall satisfy the specified minimum requirements, as per the relevant MOSRTH Specifications. The design of mixes shall be done by Marshall method.
- (iv) For the design of mixes, use of refusal density criterion can be adopted.
- (v) The grade of bitumen/modified bitumen shall be selected by the Concessionaire keeping in view the traffic, rainfall and other environmental conditions.

5.8 **Performance Evaluation**

- (i) Pavement performance evaluation shall be done by the Independent Engineer in accordance with tests based on good industry practice.
- (ii) Roughness in each lane for full length shall be measured by calibrated BI periodically.

- (iii) The structural evaluation of the pavement shall be made by taking deflection measurements every 5 years, in accordance with the procedure given in IRC: 81, unless needed earlier for stretches exhibiting severe distress during the operation and maintenance period.

5.9 Widening and Strengthening of Existing Pavement to Two Lane / Two Lane Plus (with Paved Shoulders)

5.9.1 The requirement of strengthening (overlay thickness) for the existing pavement shall be assessed as per the procedure laid down in IRC: 81. The pavement thickness in the widened portion shall be kept equal to the thickness of the existing pavement plus the thickness of the overlay as assessed above, unless specified otherwise. The overlay on the existing pavement and widened portion shall be uniform in thickness and composition. It shall be ensured that the thickness of the bituminous surfacing in the widened portion shall not be less than the equivalent thickness of bituminous surfacing over the existing pavement.

5.9.2 The pavement shall be widened symmetrical to the existing centerline or on one side only depending on the placement of the existing road within the right of way. This aspect may be decided in consultation with the Independent Engineer, in case not specified in the relevant schedule of the Concession Agreement.

The earthwork in subgrade in widened portions and shoulders shall be compacted to at least 97% of the maximum dry density obtained by heavy compaction (IS: 2720, Part 8).

5.9.3 Before strengthening treatment is prescribed, a detailed pavement condition survey and evaluation shall be carried out in accordance with IRC: 81 to determine:

- (i) The extent of distress and nature of deficiency in the existing pavement structure, and
- (ii) Whether any special treatments e.g. provision for remedying reflection cracking, pavement internal drainage, subgrade improvement/reconstruction, or rectification of any other deficiencies are warranted.

5.9.4 Before implementing the strengthening treatment, the existing pavement surface profile shall be checked and if found deficient, shall be corrected by providing a suitable profile corrective course or by milling and recycling. The profile corrective course shall meet the following requirements:

- (i) The profile corrective course shall not form part of the overlay thickness.

- (ii) Where the maximum thickness of profile corrective course is not more than 40 mm, it shall be constructed as an integral part of the overlay course. In other cases, the profile corrective course shall be constructed as a separate layer.
 - (iii) Where it is to be laid as integral part of the overlay/strengthening course, the profile corrective course material shall be of the same specifications as that of the overlay/strengthening course.
- 5.9.5 Necessary corrective measures to treat the identified deficiency vide paras 5.9.3 and 5.9.4 above, shall be taken along with strengthening of the pavement.
- 5.9.6 Any stretches in which the pavement is damaged/deteriorated to such an extent that the use of Benkelman Beam method may not result in a realistic assessment of the strengthening treatment, pavement in such stretches shall be designed using the design procedure for new pavements.
- 5.9.7 Where an existing pavement is built over an untreated expansive/black cotton soil subgrade, its improvement/strengthening/widening shall be treated separately. Such stretches shall require reconstruction with provision of adequate measures such as replacement or treatment of expansive subgrade and shall be designed as new pavement in accordance with the procedure specified in para 5.4 and IRC:37. Such stretches shall be specified in Schedule-B of the Concession Agreement.
- 5.9.8 No granular layer shall be provided over an existing bituminous surfacing. Where it is envisaged to strengthen grossly deficient existing road with a granular base layer in addition to the bituminous overlay, the requirements specified in paras 5.10.6 and 5.10.7 shall apply.
- 5.9.9 *Paved Shoulders*
- (i) Paved shoulders shall be constructed, where specified.
 - (ii) The width of paved shoulders shall be 1.5 m unless specified otherwise.
 - (iii) The paved shoulders shall be constructed in layers, each matching the thickness of the adjoining pavement layer. The work shall be carried out in accordance with Clause 407 of MOSRTH Specifications.
 - (iv) Where the existing pavement is to be widened to two lanes with paved shoulders, the pavement layers in the main carriageway and in the paved shoulder width shall be laid and compacted together.
 - (v) If the thickness of the existing paved shoulders, if any, is less than the thickness

of the adjacent pavement, the paved shoulders shall be re-constructed to the new pavement thickness.

- (vi) The overlay on the main carriageway pavement and on the paved shoulders shall be uniform in thickness and composition.

5.9.10 Granular Shoulders

Material for granular layer on shoulders shall be well graded natural sand, moorum, gravel, crushed stone or combination thereof, conforming to Clause 401 of MOSRTH Specifications and having soaked CBR value of not less than 30%. The granular layer shall be compacted to at least 98% of the maximum dry density for the material determined as per IS: 2720 (Part 8).

5.10 Design of Strengthening Treatment (Overlay)

5.10.1 IRC:81 shall be followed for design of strengthening treatment. The guidelines provide the method for determining the characteristic deflection using Benkelman Beam and then working out the overlay thickness for the design traffic.

5.10.2 The characteristic deflection for design purpose shall be determined by the following formula:

$$D_c = \bar{X} + 2 \sigma$$

Where, D_c = Characteristic Deflection (mm)

\bar{X} = Mean Deflection (mm)
(determined on the basis of individual deflection corrected for temperature and seasonal variation)

σ = Standard Deviation

5.10.3 Design Period and Minimum Requirements

- (i) Pavement strengthening shall be done for a design period of 10 years or equal to the operation period, whichever is more. Strengthening in stages shall be permissible subject to the requirements given in para (ii) below.
- (ii) The Concessionaire shall ensure the following requirements as a minimum for design of strengthening measures:
 - (a) Initial strengthening for a design period of not less than eight years.
 - (b) Subsequent overlay at the end of the initial design period, or earlier, if the surface roughness exceeds the value specified in Schedule-K of the

Concession Agreement or if any structural distress is observed. The overlay shall be designed to extend the pavement life for at least five years at a time.

- (c) The riding quality of the pavement shall be measured periodically and if the roughness exceeds the specified value, the pavement strength shall be evaluated based on current deflection measurements and traffic projections for the next five years, at least. In case any strengthening treatment is required, the same shall be implemented, otherwise the wearing course be renewed by providing a minimum 25 mm thick bituminous surfacing conforming to the existing wearing course specifications.

5.10.4 *Design Traffic*

The design traffic shall be estimated in terms of the cumulative number of standard axles (8160 kg) to be carried by the pavement during the design period as per the procedure described in para 5.5 of this Section.

5.10.5 The thickness of bituminous overlay shall be determined on the basis of the characteristic deflection and the design traffic as per the procedure outlined in IRC:81. The guidelines give the thickness of overlay required in terms of bituminous macadam. The thickness of bituminous overlay for pavement strengthening shall not be less than 50 mm.

5.10.6 The overlay, so determined for the existing pavements in terms of Bituminous Macadam can be modified to provide for other compositions, including the combination of granular layers of WBM/WMM and bituminous treatment. The equivalent overlay thickness can be determined using the following equivalency factors as per Clause 7.4 of IRC: 81;

$$100 \text{ mm of BM} = 150 \text{ mm of WBM/WMM}$$

$$100 \text{ mm of BM} = 70 \text{ mm of DBM/SDBC/BC}$$

5.10.7 The type of material to be used in overlay construction will depend upon several factors such as design traffic, thickness, condition and type of existing bituminous surfacing and convenience of construction. If it is proposed to strengthen an existing weak pavement structure with granular construction followed by bituminous surfacing, the following requirements shall be satisfied:

- (i) The existing bituminous surfacing shall be completely removed by scarifying /

milling before laying WBM/WMM layers. It will be ensured that the underlying layer is not disturbed.

- (ii) If the thickness of the scarified/milled layer is 40 mm or more, the existing pavement thickness shall be made up by increasing the overlay thickness correspondingly.
- (iii) The thickness and composition of bituminous surfacing over the granular layer shall conform to the recommended surfacing and thickness in para 4.2.3 (Bituminous Surfacing) of IRC:37.

5.10.8 *Bituminous Mix for Overlay*

The specifications for the bituminous mixes for the overlay shall be as specified for bituminous surfacing for new pavement sections vide para 5.7.3 of this Section.

5.10.9 *Pavement Performance Requirements and Evaluation*

The strengthened pavement shall satisfy the minimum standard and maintenance requirements specified for new pavement sections in para 5.4.3 of this Section and Schedule-K of the Concession Agreement.

The performance measurement and evaluation will be done as per the procedure described in para 5.8 of this Section.

5.11 **Construction, Workmanship and Quality of Work**

All materials, construction operations, workmanship, and the surface finish of the quality of completed construction for all pavement works including subgrade, sub-base, base course, bituminous surface courses for new pavements and for widening and strengthening works shall conform to the specified requirements and specifications and comply with the relevant provisions of Section 900 of the MOSRTH Specifications.

5.12 **Premature Distress**

Notwithstanding the minimum design, specifications and standards specified in the preceding paras for new pavements and strengthening of existing pavements, if the pavement shows premature distress in the form of cracking, rutting, patching, loss of camber or any other structural or functional distress, necessary remedial measures by strengthening/resurfacing shall be undertaken after proper investigation for conforming to the minimum requirements prescribed in Schedule-K of the Concession Agreement.

5.13 Detailed Design Report

The new pavement design and strengthening proposals formulated on the basis of the detailed investigations and studies shall be communicated to the Independent Engineer for review and comments, if any. The proposal shall be accompanied by Data Collection, Data Evaluation and Design Reports.

5.13.1 Data Collection Report

The data collection report shall include:

- (i) Soil investigation data for new pavements as per Table 13.2 of IRC: SP:19. Report shall include OMC-Dry density relationship with heavy compaction and soaked CBR values, in addition to other data and information as per the prescribed proforma.
- (ii) Test values of aggregate for pavement courses as per Tables 13.3 and 13.4 of IRC:SP:19. All tests as per requirements of MOSRTH Specifications shall be reported in addition to the tests and information included in the above mentioned Tables.
- (iii) Classified traffic counts in Proforma 1 of IRC:SP:19.
- (iv) Axle load surveys and VDF values for each category of commercial vehicles as per Proforma 4 of IRC:SP:19.
- (v) Estimation of traffic growth and traffic projections for pavement design.
- (vi) Pavement condition data in the Proforma given in Table 2 of IRC:81.
- (vii) Pavement roughness data measured by Bump Integrator as per IRC:SP:16.
- (viii) Pavement Deflection Data measured by Benkelman Beam as per the procedure detailed in IRC:81. Pavement deflection data shall be recorded in the prescribed Proforma vide Table 3 of IRC:81.

The deflection data shall be accompanied with the characteristics of the subgrade soil covering type of subgrade soil, field moisture content (at the time of deflection survey), average annual rainfall in the area, and pavement temperature at the time of deflection survey.

- (ix) Any other relevant information required by the Independent Engineer for review and comments, if any.

5.13.2 *Data Evaluation Report*

The report shall inter alia cover:

- (i) Data evaluated - soil characteristics and subgrade strength, pavement distress, pavement deflection, riding quality, skid resistance, drainage aspects, etc.
- (ii) Pavement deficiencies, drainage and constraints.
- (iii) Any other relevant details.

5.13.3 *Detailed Design Report*

The Concessionaire shall furnish the detailed design of the preferred solution along with any special treatment proposed for adoption. Any departures from the specifications, stated herein, shall be supported with authentic standards and specifications and accepted practice.



Section 6
Roadside Drainage



SECTION 6

ROADSIDE DRAINAGE

6.1 General

- 6.1.1 The design and construction of surface and sub-surface drains for highway drainage shall be carried out in accordance with the requirements of this Section.
- 6.1.2 Efficient drainage system shall be provided for the entire Project Highway including structures and facilities.
- 6.1.3 For quick disposal of precipitation on the road surface, the carriageway, shoulders and median shall have the requisite camber/crossfall and longitudinal gradient as per the values specified in Section 2 of this Manual.
- 6.1.4 The natural drainage of the area shall not be disturbed.
- 6.1.5 The design of drains shall be carried out in accordance with IRC:SP:42 and IRC:SP:50.
- 6.1.6 Construction of surface and sub-surface drains shall be carried out in accordance with the requirements of Clause 309 of the MOSRTH Specifications.
- 6.1.7 Efficient drainage arrangements for road sections in cuttings and at underpasses shall be made. Where it is not possible to drain out water using gravity flow, necessary arrangements for pumping shall be made.

6.2 Surface Drainage

- 6.2.1 The water from road and adjacent areas shall be intercepted and carried through road side drains to natural outfalls.
- 6.2.2 The drains shall have sufficient capacity to carry normal peak run-off without overflowing.
- 6.2.3 The selection of type of roadside drains shall be based on the magnitude and duration of flow. The roadside drains shall be designed on the principles of flow in open channel.
- 6.2.4 The estimation of design discharge (peak run off) and design of drain sections shall be made in accordance with the procedure given in IRC:SP:42.

- 6.2.5 The open drains shall be located sufficiently away from the toe of embankment. When the drain is unlined it shall be beyond 4H:1V imaginary line drawn from the edge of the roadway.
- 6.2.6 The road side drains shall not pose any danger to traffic, slopes of cuttings, embankment, pavement or structures.
- 6.2.7 As far as possible, longitudinal slope shall not be less than 0.5 percent for lined drains and 1.0 percent for unlined drains.
- 6.2.8 The side slopes of the unlined drains shall be as flat as possible and shall not be steeper than 2H:1V.
- 6.2.9 The drains shall be provided with CC lining in the following situations:
 - (a) When due to space constraint, the drains are located near the toe of the embankment or near structures.
 - (b) Drains located in paved areas.
 - (c) Flow velocity is more than 0.3 m/s to 1 m/s in silt and sand and more than 1.5 m/s in stiff clay.

6.3 Median Drainage (where dual carriageway is provided)

- 6.3.1 Proper arrangement for drainage of median shall be provided. The median drain should have adequate longitudinal slope to the nearest culvert to drain off transversely.
- 6.3.2 Earthen surface in the median shall not be sloped towards carriageway to drain on the pavement, to avoid washed away soil getting deposited on the pavement making it slippery and accident prone.
- 6.3.3 Turfed/paved median of up to 5 m width with kerbs could be crowned for drainage across the pavement.
- 6.3.4 In superelevated sections, proper arrangement for drainage of raised carriageway and median shall be made without allowing water to drain on the other carriageway.

6.4 Drainage of High Embankment

- 6.4.1 In high embankment and approaches to bridges, proper arrangement for drainage of carriageway shall be made in order to ensure that no damage is caused to pavement, shoulders and embankment slopes.

- 6.4.2 Drainage arrangement may include provision of kerb channel at the edges of the roadway to channelize the water and CC lined chutes along the slopes at about 10 m intervals or at designed spacing to discharge the water into side channels at the bottom.
- 6.4.3 The chute drains and drains at toe of the embankment shall be of Plain Cement Concrete (M15 grade) over proper bedding.

6.5 Catch Water Drains

- 6.5.1 Suitable catch water drains shall be provided on the hill slopes above a cutting to collect and remove surface water run-off from upper reaches. These drains should be of trapezoidal shape and stone lined and cement pointed.
- 6.5.2 The catch water drains shall be designed to carry the intercepted water to the nearest culvert or natural drainage channel.
- 6.5.3 It shall be ensured that the catch water drains are provided in stable hill slopes outside the periphery of slide/unstable areas.
- 6.5.4 Where required, lined chutes shall be provided to lead the discharge to the catch pit of culvert or to a natural drainage channel.

6.6 Sub-surface Drains

- 6.6.1 The sub-surface drainage shall be provided:
- (i) for lowering the level of water table for drainage of subgrade,
 - (ii) to intercept or drain out free water in cut slopes,
 - (iii) for drainage of pervious sub-base in situations where it may not be practicable to extend the sub-base across the shoulder.
- 6.6.2 Sub-surface drains shall not be used for surface drainage.
- 6.6.3 The sub-surface drains shall be:
- (i) Close jointed perforated pipes or open jointed unperforated pipes in trenches with backfill material around pipes.
 - (ii) Aggregate drains consisting of free draining material in the trench without any pipe.
- 6.6.4 Perforated pipes and unperforated pipes shall meet the requirements of Clause 309.2 of MOSRTH Specifications.

- 6.6.5 The internal diameter of the pipe shall not be less than 150 mm.
- 6.6.6 The sub-surface drains shall be located not less than 0.5 m below the subgrade.
- 6.6.7 *Backfill Material*
- (i) Backfill material shall be free draining sand, gravel or crushed stone designed on inverted filter criteria for filtration and permeability or of an appropriate grading conforming to the requirements of Table 300.3 of MOSRTH Specifications.
 - (ii) Thickness of backfill material around the pipe shall not be less than 150 mm. The minimum thickness of material above the top of the pipe shall be 300 mm.
- 6.6.8 Sub-surface drains not located below the road pavement shall be sealed at the top.
- 6.6.9 *Use of Geo-textile*
- (i) The sub-surface drains may be designed using appropriate geo-textile to serve the functions of filtrations and separation.
 - (ii) The sub-surface drains can be provided with geo-textile either along the trench or around the pipe or both.
 - (iii) The geo-textile shall satisfy the requirements of Clause 702 of MOSRTH Specifications.
- 6.6.10 Trench excavation, laying of pipe, backfilling, and use of geo-synthetics shall conform to the requirements of Clauses 309.3.3, 309.3.4 and 309.3.5 of MOSRTH Specifications
- 6.6.11 The drain outlet shall be a free outlet and shall be prepared as per Clause 309.3.6 of MOSRTH Specifications.
- 6.6.12 *Aggregate Drains*
- (i) The trench for aggregate drain shall be of minimum 300 mm width and cut to a depth to expose the granular pavement courses to be drained.
 - (ii) Aggregate for the drain shall be gravel, stone aggregate or slag of grading as per Table 8 of IRC:SP:42.
 - (iii) The aggregate drain shall be provided with a geo-textile wrap to act as filtration and separation layer.
- 6.6.13 Design of subsoil drainage shall be based on a rational basis. Reference may be made to IRC:SP:42

6.7 Internal Drainage of Pavement Structures

- (i) Boxed type construction in which pavement is housed in earthen shoulders shall not be provided.
- (ii) The sub-base shall be extended across the shoulders for efficient drainage of pavement.
- (iii) The granular sub-base shall be of proper design and grading to perform satisfactorily as a drainage layer. The drainage layer shall not have material finer than 75 micron size.
- (iv) A suitable filter of granular material or geo-textile to act as filtration and separation layer shall be incorporated between the subgrade and sub-base to prevent clogging. Reference may be made to Section 5 of this Manual.

6.8 Survey, Investigations and Design Report

The Concessionaire shall carry out proper surveys and investigations for detailed design of the drainage system. The proposal for drainage system supported with survey investigation report and detailed design report shall be submitted to the Independent Engineer for review and comments, if any.

6.8.1 *Survey and Investigations - Drainage Studies*

The survey and investigation and drainage studies shall include:

- (i) Alignment plan, longitudinal and cross-sections, contour map.
- (ii) Hydrological data
Drainage area, water shed delineation, direction of flow, location of outfalls, existing surface drains, ground surface condition, rainfall, flood frequency, etc.
- (iii) Data for hydraulic design of drains.
- (iv) Geo-technical investigations for sub-surface strata, level of water table, seepage flow etc.
- (v) Identification of areas requiring sub-base drainage.
- (vi) Any other relevant information.

IRC:SP:19, IRC:SP:42, IRC:SP:48 and IRC:SP:50 may be referred to.

6.8.2 *Design Report*

The design report shall include:

- (i) Estimation of design discharge
- (ii) Design of surface drains
- (iii) Design of sub-surface drains
- (iv) Drainage arrangement plan
- (v) Specifications of drains
- (vi) Any additional information as required by the Independent Engineer for review of the drainage system.

Section 7
Design of Structures



SECTION 7

DESIGN OF STRUCTURES

7.1 General

- (i) All new structures up to 60 m length shall be constructed with an overall width between outermost faces of the railings/parapets/crash barriers equal to the roadway width of the approaches.
- (ii) All new structures more than 60 m length shall have minimum 7.5 m wide carriageway, unless specified otherwise in Schedule-B of the Concession Agreement.
- (iii) New structures with footpaths, where so specified in Schedule-B of the Concession Agreement, shall be constructed with an overall width of 12 m between the outermost faces of the crash barriers or railings. Raised footpaths shall be provided.
- (iv) All bridges shall be high level bridges, unless specified otherwise in the Concession Agreement.
- (v) All structures shall be designed in accordance with the relevant IRC Codes, Standards and Specifications.
- (vi) All railway level crossings (except railway sidings) shall be replaced with ROBs/RUBs, unless specified otherwise in Schedule-B of the Concession Agreement.
- (vii) Typical cross sections of the new culverts and bridges for a 2-lane highway are given in Figs. 7.1 to 7.4.
- (viii) Any utility services to be taken on the structures shall be specified in Schedule-B of the Concession Agreement.

7.2 Design Loading and Stresses

- (i) The design loads and stresses shall be as per IRC:6.
- (ii) Raised footpath shall be provided in built up areas.
- (iii) In Seismic Zones IV and V, necessary design related precautions against dislodgement of superstructure shall be taken as per Clause 222 of IRC:6.
- (iv) All the components of structures shall be designed for a service life of 100 years except appurtenances like crash barriers, wearing surface and rubberized

components in expansion joints and elastomeric bearings. All the requirements to achieve durability and serviceability shall be implemented.

- (v) For bridges in marine environment, special precautions as specified in Schedule-B of the Concession Agreement shall be taken. (Refer para 7.22)

7.3 Widening / Reconstruction of Existing Structures

7.3.1 Existing Culverts

- (i) All culverts which are structurally distressed shall be specified in Schedule-B of the Concession Agreement and shall be reconstructed as new structures.
- (ii) All existing culverts which are not to be reconstructed shall be widened equal to the roadway width of approaches.

7.3.2 Existing Bridges

- (i) All the bridges which are structurally distressed shall be specified in Schedule-B of the Concession Agreement and shall be reconstructed as new structures.
- (ii) The bridges which are sound but narrower than 7.5 m width (carriageway) shall be widened where specified in Schedule-B of the Concession Agreement.
- (iii) All existing bridges in sound condition with 7.5 m wide carriageway shall be retained.

7.4 Structure Types

- (i) Bridge superstructure may be of reinforced concrete, pre-stressed concrete or steel-concrete composite construction.
- (ii) Wherever box girders are proposed for superstructure, the minimum clear depth inside the box shall be 1.50 m with suitable openings in the diaphragms and box to facilitate inspections. Haunches of minimum size of 300 mm (horizontal) and 150 mm (vertical) shall be provided at the extreme corners of the box section.
- (iii) Bridge foundation and substructure shall be of masonry or plain or reinforced concrete. These will be designed as per the relevant IRC Codes / MOSRTH Specifications.
- (iv) Innovative structures like continuous bridges, precast pre-tensioned girder bridges and segmental bridges may be adopted, where considered appropriate.

The design of continuous bridges shall be governed by IRC:SP:66. Design of segmental bridges shall be governed by IRC:SP:65 and design of pre-cast pre-tensioned girder bridges shall be governed by IRC:SP:71.

7.5 Hydrology

All the structures shall have adequate waterway. The design discharge shall be evaluated for flood of 50-year return period.

7.6 Sub-Surface Investigations

7.6.1 The Concessionaire shall carry out independent sub-surface investigations to establish the soil parameters required for detailed design of each foundation separately, if necessary, in accordance with relevant provisions of IRC:78 and MOSRTH Specifications.

7.6.2 For single span structures (bridges, overpasses, ROBs etc.), bores shall be taken at each of the abutment locations. For structures having more than one span, at least one bore shall be taken at each of the foundation locations.

7.7 Culverts

7.7.1 *New Culverts*

Reinforced concrete pipes for culverts shall be of NP 4 type, conforming to the requirements of IS: 458. Minimum diameter of pipes for new pipe culverts shall be 1200 mm (Internal diameter).

7.7.2 *Existing Culverts*

- (i) Existing pipe culverts of diameter 900 mm and above, which are in sound condition and functioning satisfactorily, may be extended using pipes of same diameter.
- (ii) All culverts having pipe diameter less than 900 mm shall be replaced with pipes of minimum 1200 mm diameter.
- (iii)
 - (a) Suitable bedding for pipes shall be provided as per Clause 2904 of MOSRTH Specifications
 - (b) Minimum cushion of 600 mm shall be provided for pipe culverts.
- (iv) Floor protection shall be as specified in the relevant IRC Specifications.

7.8 Prestressing

- (i) The Concessionaire shall engage specialized agency in consultation with Independent Engineer for rendering total service contract. The Concessionaire shall also obtain the necessary certificate from the specialized agency engaged, that the work has been carried out in accordance with the prescribed standards and specifications.
- (ii) The Concessionaire shall submit fabrication drawings, detailing of prestressing cables, anchorages, couplers, chairs and supports, templates or forms for holding anchorage assemblies, stressing schedule, etc for review and comments of Independent Engineer, if any, at least 45 days prior to the scheduled date of commencement of the prestressing work.
- (iii) The sheathings shall be either in mild steel as per clause 3.6.1 or HDPE as per clause 3.6.2 of IRC:18. They shall comply with the requirements specified in Appendix 1A/1B of IRC:18 and the Concessionaire shall obtain a test certificate of confirmation from the manufacturer and furnish for review and comments of Independent Engineer, if any, before bringing the proposed type of sheathing to the site.
- (iv) In order to keep the number of joints in a duct to the minimum possible, the sheathings shall be as long as practical from handling and transportation considerations without getting damaged. Sheathing damaged during handling or transportation shall not be made good and used in the works.
- (v) The joints of the mild steel sheathings shall be water tight complying with the requirements given in Appendix 2 of IRC:18.
- (vi) Pull-in or push-in of the prestressing strands shall be mechanized.
- (vii) Temporary tendons shall be inserted in the sheathing or the sheathing shall be stiffened by other suitable method during concreting. Cables shall be threaded after the concreting. Tendons shall not be placed until immediately prior to stressing. Tendons shall be handled with care to avoid damage or contamination, to either tendon or the sheathing. Any tendon damaged or contaminated shall be cleaned or replaced.
- (viii) Prestressing accessories like jacks, anchorages, wedges, block plates, couplers etc being patented items shall be obtained from only authorized manufacturers with in-house testing facilities.
- (ix) All prestressing components and accessories shall be subject to acceptance tests and reviewed prior to their actual use on the works. Testing of anchorage cable

assemblies shall be carried out in consultation with Independent Engineer. Couplers which connect two tendons to form a continuous tendon shall be tested in the same way as anchorages formed by mechanical means.

- (x) Jacks and pumps shall be got calibrated from any accredited laboratory prior to use and then at intervals not exceeding three months.
- (xi) Grouting shall be carried out as early as possible, but not later than 10 days of stressing of a tendon. Grouting of post-tensioned cables shall be carried out as per the recommended practice specified in Appendix 5 of IRC:18.
- (xii) Jointing of pre-cast units by application of cement mortar shall not be permitted. The Concessionaire shall submit adequate data in support of the proposed method of jointing the pre-cast units for the review and comments of Independent Engineer, if any.

Whatever may be the method of jointing, the holes of prestressing steel shall be accurately made to meet one another in true alignment at ends and to ensure even transfer of compression from one unit to another.

- (xiii) Care shall be taken to ensure that the jointing material does not enter the duct or press the sheath against the prestressing steel.
- (xiv) Guidelines for use of external and unbonded prestressing tendons in bridge structures can be considered as per IRC:SP:67, wherever considered appropriate.

7.9 Form Work

The Concessionaire shall be responsible for the safe, workable design and methodology for all temporary or permanent forms, staging and centering required for supporting and forming the concrete of shape, dimensions and surface finish as shown on the drawings. The following guidelines shall be adopted:

- (i) Only steel formwork shall be permitted.
- (ii) Shuttering oil (release agent) used shall be such, which permits easy removal of shutters without leaving stains or other marks on the surface of the concrete. Requirements given under Clause 3.5 of IRC:87 shall also be complied with.
- (iii) In case of tubular staging of heights more than 10 m, special attention shall be paid to the structural adequacy of the system, efficacy of the connections (clamps etc), and foundations. Foundation blocks of adequate thickness in M15 cement concrete shall be provided under the base plates to prevent unequal settlements. All bent tubular props shall be straightened before re-use and the member with

deviation from straightness more than 1 in 600 of its length shall not be re-used. For re-used props, suitable reduction in the permissible loads shall be made depending upon their condition in accordance with recommendations of the manufacturer and as reviewed by Independent Engineer.

- (iv) In case of prestressed concrete members, the side forms shall be removed as early as possible and the soffit forms shall permit movement of member without restraint, when prestress is applied. Form supports and forms for cast-in-situ members shall not be removed until sufficient prestress has been applied to carry all anticipated loads during construction stage.

7.10 Foundations and Sub-structures

7.10.1 The design of foundations and sub-structures shall conform to IRC:78.

7.10.2 Open Foundations

The design of open foundations shall conform to IRC:78. Floor protection shall be provided as per Section 2500 of MOSRTH Specifications.

7.10.3 Pile Foundations

- (a) The construction of pile foundation in bridges has been introduced rather recently. The design of pile foundations shall be done as per specialized literature and IRC:78. The Concessionaire shall submit a method statement to Independent Engineer for review and comments, if any. The method statement shall be supported by the following:
 - (i) Bore-log details for each foundation;
 - (ii) Design assumptions;
 - (iii) Design calculations both for new pile or group of piles and for pile type;
 - (iv) Type of piles- Bored cast-in-situ piles, driven piles and girder piles;
 - (v) Procedure adopted for installation of piles;
 - (vi) Arrangements for load testing of piles;
 - (vii) Format for reporting of tests results.
- (b) The Concessionaire shall submit the following information to Independent Engineer for review and comments, if any, regarding proposed proprietary system of piling:
 - (i) Diameter, length and type of pile proposed for the structure;

- (ii) General features of the process/system along with specifications and standards;
- (iii) Authenticated copies of license/agreement, if any;
- (iv) Details of plant and equipment to be used along with the names of manufacturers and name of process/system;
- (v) Details of projects where the process/system has been successfully used;
- (vi) Limitations, if any;
- (vii) Acceptance tests and criteria;
- (viii) Installation & maintenance procedure and schedule;
- (ix) Performance Warranty

7.10.4 Well Foundations

- (a) For conventional method of well sinking, the Concessionaire shall submit a method statement to Independent Engineer for review and comments, if any, including the following:-
 - (i) Design calculations and drawings,
 - (ii) Procedure for sinking and plugging of well,
 - (iii) Format for reporting of test results.
- (b) If proprietary system of well sinking like jack down method is proposed to be used, the Concessionaire shall submit relevant information to Independent Engineer for review and comments, if any, covering the following inter-alia:
 - (i) General features of the system along with specifications and standards and justification for the thickness of steining proposed to be adopted;
 - (ii) Authenticated copies of license/agreement, if any;
 - (iii) Details of plant and equipment to be used along with the names of manufacturers and name of process/system;
 - (iv) Details of projects where the system has been successfully used;
 - (v) Limitations, if any;
 - (vi) Acceptance tests and criteria;
 - (vii) Installation & maintenance procedure and schedule;
 - (viii) Performance Warranty

7.11 Approach Slabs

Approach slab shall be provided as per provision in Clause 217 of IRC:6 and Section 2700 of MOSRTH Specifications.

7.12 Superstructures

7.12.1 The design of reinforced and prestressed concrete super structures shall be as per IRC:21 and IRC:18 respectively. The design of steel and steel-concrete composite super structures shall conform to IRC:22 and IRC:24 respectively.

7.12.2 The Concessionaire shall submit the Method Statement to Independent Engineer for review and comments, if any, indicating the following inter alia:

- (i) Sources of materials,
- (ii) Design, erection and removal of formwork,
- (iii) Layout of casting yard together with necessary details,
- (iv) Production, transportation, laying and curing of concrete,
- (v) Sequence of concreting in cast-in-situ construction, side shifting of girders, if applicable and placing of girders on the bearings,
- (vi) Details of construction joints,
- (vii) Prestressing system, if required,
- (viii) Methodology and equipment for side shifting and launching of pre-cast girders,
- (ix) Key personnel for execution and supervision,
- (x) Testing and sampling procedure,
- (xi) Equipment details.

7.13 Bearings

7.13.1 All bearings shall be easily accessible for inspection, maintenance and replacement. Design and specifications of bearings shall be as per IRC:83 (Part I, II & III). Spherical bearings shall conform to the requirements of BS: 5400. The materials of bearings may, however, conform to the relevant BIS codes nearest to the specifications specified in BS: 5400. The drawing of bearings shall include the layout plan showing exact location on top of pier and abutment cap and the type of bearings i.e. fixed/free/rotational at each location along with notes for proper installation.

- 7.13.2 The Concessionaire shall procure bearings only from the manufacturers approved by MOSRTH.
- 7.13.3 The Concessionaire shall submit detailed specifications, designs and drawings including installation drawings and maintenance manual incorporating the replacement procedure to the Independent Engineer for review and comments, if any.
- 7.13.4 The Concessionaire shall obtain a complete Quality Assurance Programme (QAP) from the manufacturer for the review and comments, if any, by Independent Engineer. The QAP shall give full details of the process of quality control, raw material testing, various stages of manufacture, testing on bearing components as well as testing on complete bearing in conformity with relevant part of IRC:83 prior to the commencement of manufacture of the bearings.
- 7.13.5 In addition to the routine testing of the materials and bearings at the manufacturer's premises, the Concessionaire shall arrange testing of random samples of one per cent (minimum one number of each type) of bearings from independent agency approved by Independent Engineer. The bearings shall be selected by Independent Engineer and duly sealed in his presence for dispatch to the approved independent agency.
- 7.13.6 The Concessionaire shall submit a certificate of confirmation regarding quality control measures taken during manufacture of the bearings and the material conforming to the prescribed standards and specifications. Full lot of bearings of the sample found to have inferior specifications to those certified by the manufacturer or to have a major discrepancy in material specifications or fail to meet the acceptance criteria, shall be rejected.

7.14 Expansion Joints

- i) Structures shall have minimum number of expansion joints. This may be achieved by adopting longer spans, making the superstructure continuous or using integrated structures. Expansion joints shall conform to IRC: SP:69. The Concessionaire shall furnish guarantee/proprietary indemnity bonds from the manufacturers/suppliers of expansion joints for a period of 10 years.
- ii) Rubberized components of expansion joints of all the existing structures older than 15 years shall be replaced.

7.15 Wearing Coat

- i) The wearing coat shall be cement concrete in case of curved bridges and box

girder bridges, in other cases it may be either bituminous concrete or cement concrete. The wearing coat shall have two directional camber and shall be in conformity with Section 2700 of MOSRTH Specifications

- ii) Wearing coat in damaged/distressed condition shall be replaced by bituminous wearing coat.

7.16 Reinforced Earth Retaining Structures

7.16.1 Reinforced earth retaining structures shall not be provided for height more than 6 m and near water bodies. Such structures should be given special attention in design, construction, maintenance and selection of system/system design.

7.16.2 A qualified and experienced technical representative of the approved supplier/manufacturer shall be present on site throughout during the casting and erection phases, to ensure that the quality of the works performed by the Concessionaire is in accordance with the specifications.

7.17 River Training and Protective Works

River training and protective works shall be provided wherever required, for ensuring the safety of bridges and their approaches on either side. The special features and design of various types of river training and protective works shall be in accordance with IRC:89.

7.18 Safety Barriers

- (i) For bridges without foot paths, concrete crash barriers shall be provided at the edge of the carriageway on all new bridges.
- (ii) The type design for the crash barriers may be adopted as per IRC:5. The design loading for the crash barriers shall be as per Clause 209.7 of IRC:6.
- (iii) For bridges with foot paths, pedestrian railing shall be provided on the outer side of footpath.
- (iv) The railings of existing bridges shall be replaced by crash barriers, where specified in Schedule-B of the Concession Agreement.
- (v) Parapets/Railings of the existing bridges/culverts to be repaired/replaced shall be specified in Schedule-B of the Concession Agreement.

7.19 Rail-Road Bridges

7.19.1 ROB/RUB shall be provided on all railway level crossings, unless otherwise specified, in Schedule-B of the Concession Agreement

7.19.2 *Road Over Bridge (Road over Railway line)*

- (i) In case the bridge is to be provided over an existing level crossing, 2-lane bridges shall be constructed with overall width as given in sub-para 7.1(i) of this Section. The horizontal and vertical clearances to be provided shall be as per requirement of the Railway authorities.
- (ii) In general, the Railways require that in the railway boundary there is no solid embankment, provision is made for future expansion of railway line, provision of vertical clearances as per requirement of electric traction and excavation for foundations shall be sufficiently away so as not to endanger the safety of the running tracks.
- (iii) The Concessionaire shall be required to obtain approvals of all designs and drawings from the concerned Railway authorities. The design of structure shall be in accordance with relevant IRC codes.
- (iv) The construction of ROB within the Railway boundary shall be under the supervision of Railway officers.
- (v) Approach gradient shall not be steeper than 1 in 40.

7.19.3 *Road under Bridges (Road under Railway line)*

- (i) Full roadway width as in the approaches shall pass below the bridge structure. The service roads shall be continued in the bridge portion also.
- (ii) The vertical and lateral clearances shall be as per guidelines given in Section 2 of this Manual.
- (iii) These structures shall be designed to carry railway loads. The Concessionaire shall be required to obtain approvals of all designs and drawings from the concerned railway authorities. The design of structure shall be in accordance with relevant Railway codes.
- (iv) The construction of RUB and its approaches shall be undertaken in conformity with the terms specified in the approval granted by the Railway authorities.

7.20 Grade Separated Road Structures

7.20.1 The location and type of grade separated road structures to be provided on the Project Highway shall be as specified in Schedule-B of the Concession Agreement.

7.20.2 The vertical and lateral clearances shall be as per requirements given in Section 2 of this Manual. Design of structures shall conform to the requirements specified in this Manual.

7.21 Drainage

An effective drainage system for the bridge deck structure shall be planned and designed so as to ensure that water from the deck is taken down to ground level/ drainage courses by adequate size of drainage spouts and pipes.

7.22 Structures in Marine Environment

Necessary measures/treatments for protecting bridges in marine environment shall be as specified in Schedule-B of the Concession Agreement.

7.23 Repairs and Strengthening

(i) Repairs and Strengthening of structures to be carried out shall be specified in Schedule-B of the Concession Agreement This shall be based on detailed condition survey of existing structures and shall bring out the nature and extent of repairs to be carried out, covering the following in addition to other specific requirements:-

- (a) Repair/replacement of damaged railings and parapets, provision of crash barriers,
- (b) Replacement of wearing coat (old wearing coat shall be removed and replaced by bituminous wearing coat),
- (c) Replacement of expansion joints,
- (d) Replacement of bearings,
- (e) Structural repairs to substructure/super structure,
- (f) Repair to flooring and protection works.

(ii) The Concessionaire shall submit repairs and strengthening plan for structures in para (i) above to Independent Engineer for review and comments, if any. For all other structures with minor deficiencies, not affecting structural

inadequacies, appropriate repair measures may be proposed and submitted to Independent Engineer for review and comments, if any.

- (iii) Strengthening/rehabilitation work shall be carried out in accordance with IRC:SP:40 or by any other acceptable method according to international practice.
- (iv) The Concessionaire shall take up repair and widening of existing bridge at a particular site only after making all arrangement for diversion of traffic so as to ensure that a smooth flow of traffic is maintained. The Concessionaire shall take all precautions to guard against any accident of traffic due to such diversion and shall use all necessary road signs, etc. for the purpose. After completion of repair and widening of the existing bridge, temporary works carried out for such diversions shall be made good by the Concessionaire.

7.24 Design Report

The Concessionaire shall furnish the design report including the following to the Independent Engineer for his review and comments, if any.

- (i) Sub surface exploration report as per IRC:78 as specified in para 7.6 above.
- (ii) Hydrological investigation report including design discharge calculation for the bridges, in case of any change in the proposed waterway of any bridge as specified in para 7.5 above.
- (iii) Design and drawings of foundations, substructure and superstructure of structures.
- (iv) Detailed report regarding the bridges whose width is less than the roadway width and the proposal for its improvement.
- (v) Any other information relevant to the design report.

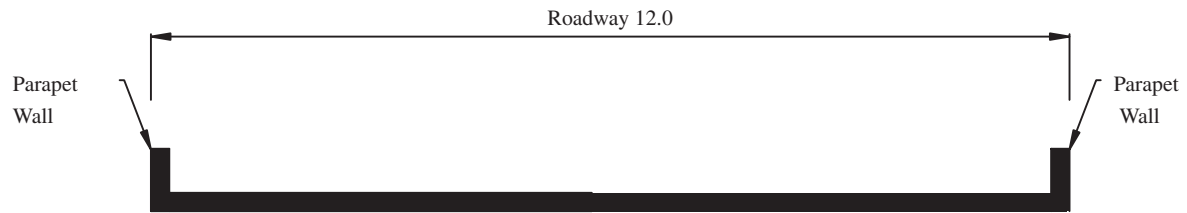

Note:
All dimensions are in metres.

Width of culvert at deck level
(Plain/rolling terrain)
2-lane carriageway

Fig. 7.1

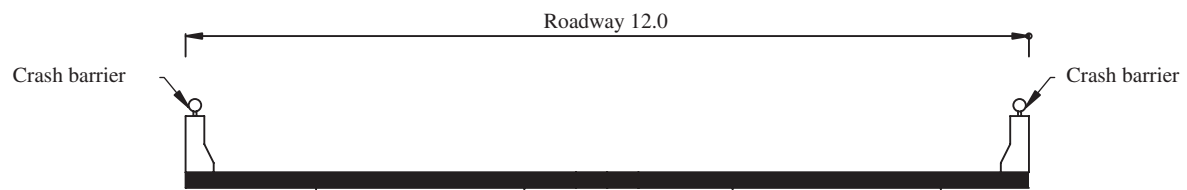

Note:
All dimensions are in metres.

Width of bridge (without footpath) at deck level
(Plain/rolling terrain up to 60 m length)
2-lane carriageway

Fig. 7.2

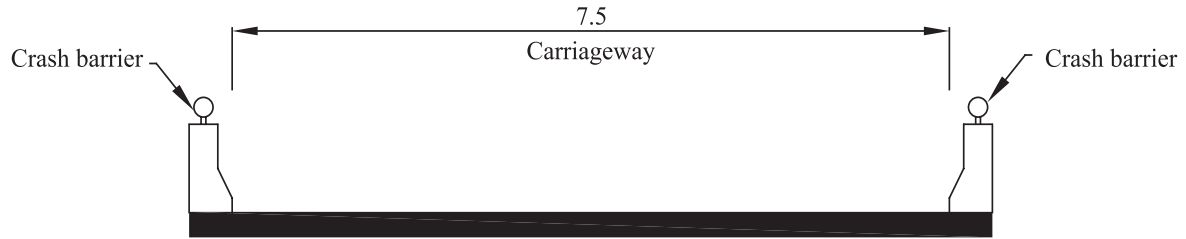

Note:
All dimensions are in metres.

Width of bridge at deck level
(Bridges above 60 m length)
2-lane carriageway

Fig. 7.3

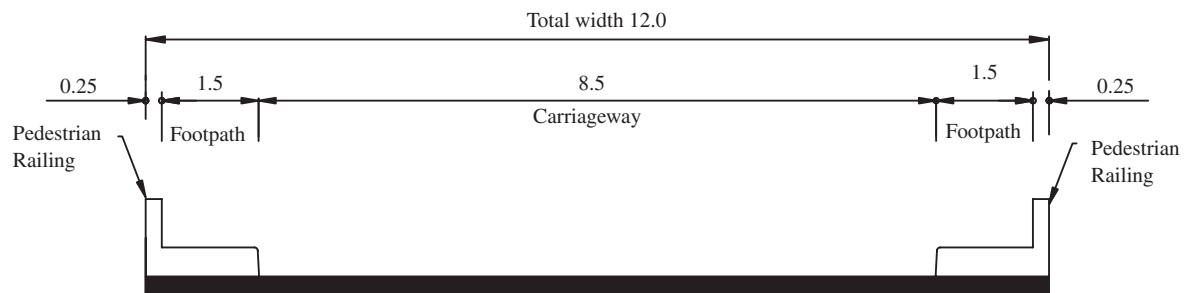

Note:
All dimensions are in metres.

Width of bridge at deck level
(Built-up area)
2-lane carriageway with footpath

Fig. 7.4



Section 8

**Materials and Specifications
for Structures**



SECTION 8

MATERIALS AND SPECIFICATIONS FOR STRUCTURES

8.1 General

- (i) All materials to be used in the structures shall be in conformity with the IRC/MOSRTH Specifications, unless specified otherwise in this Section. If the Concessionaire proposes to use any material, which is not covered in IRC/MOSRTH Specifications, it shall conform to relevant Indian Standards, if there are any, or to the requirements specified in this Manual. Proprietary products proven by international usage in comparable bridge projects, proposed to be used shall be supported with authenticated licensing arrangement with the manufacturer.
- (ii) The Concessionaire shall identify the proposed sources of materials and submit the proposal to IE for review and comments, if any, prior to delivery. If it is found that proposed sources of supply do not produce uniform and satisfactory products at any time during execution, the Concessionaire shall procure acceptable materials conforming to the specifications from other sources.
- (iii) The samples required for review shall be supplied well in advance, at least 48 hours or minimum time required for carrying out the relevant tests, whichever is more. Delay in submission of samples shall not be acceptable as a reason for delay in completion of the works/extension of time for completion.
- (iv) In case of manufactured items, the Concessionaire shall submit to the Independent Engineer for review and comments, if any, the details pertaining to the product/ process/system covering inter-alia:
 - (a) General features of the product/process/system along with specifications and standards adopted for the product/process/system;
 - (b) Authenticated copies of license/agreement;
 - (c) Name of manufacturer and name of product/process/system;
 - (d) Details of projects where the product/process/system has been successfully used;
 - (e) Limitations, if any;
 - (f) Acceptance test and criteria;

- (g) Installation & maintenance procedure and schedule; and
- (h) Performance warranty
- (v) The Concessionaire shall set up a full-fledged laboratory at site, as per the agreement for testing of all materials and finished products. He shall make arrangements for additional/confirmatory testing of any material including imported materials/products for which facilities at site laboratory are not available.

8.2 Structural Concrete

- 8.2.1 The Concrete for use in structures shall conform to the provisions in Clauses 302.6 to 302.9 of IRC:21 and Section 1700 of MOSRTH Specifications. Wherever High Performance Concrete (HPC) is proposed to be used, the same shall conform to the provisions of IRC:SP:70. Sampling and Testing of Concrete shall be as per Clause 302.10 of IRC:21. Acceptance criteria for concrete shall conform to Clause 302.11 of IRC:21. Concrete to be produced shall conform to the requirements as specified below.
- 8.2.2 A dense and well compacted concrete provides effective protection against corrosion of steel in reinforced/prestressed concrete members. To achieve this, the Concessionaire shall pay special attention to the following elements, which have a bearing on the production of a durable concrete:-
- (i) Quality of materials - cement, aggregate, water and admixtures, both mineral and chemical,
 - (ii) Mix design,
 - (iii) Mixing and placing of concrete - Concrete shall preferably be produced in a mixing and batching plant,
 - (iv) Vibration and compaction,
 - (v) Curing,
 - (vi) Cover to reinforcement/tendons, and
 - (vii) Detailing.
- 8.2.3 The following points are also important in production of durable concrete, which shall be duly considered and adopted:-
- (i) Minimum chloride content in concrete as specified in IRC:21,
 - (ii) Regular testing of water used for making concrete as per IRC:21,

- (iii) Compatibility testing of admixtures with type of cement,
- (iv) Permeability test for concrete,
- (v) Testing of aggregates for alkali-silica reaction.

8.2.4 The mix designs for concrete shall be got reviewed by the Independent Engineer prior to construction.

8.3 Cement

Any type of cement specified in IRC:21 may be used for the works subject to limitations, if any, specified therein.

8.4 Coarse Aggregates

- (i) Before the commencement of the works, at least three samples in accordance with the procedure laid down in IS: 2430 shall be taken for each quarry source to ascertain the quality, suitability and fitness of the available material for use in the works. Fresh tests shall be conducted, in case there is any change in the source or the type of rock being quarried. The proposal, along with a copy of test reports, shall be submitted to the Independent Engineer for review and comments, if any.
- (ii) Aggregate having more than 0.5% of sulphate as SO_3 with water absorption more than 2% of its own weight shall not be used.
- (iii) In case of doubt, the alkali-aggregate reactivity shall be tested in accordance with IS: 2386 (Part 6). Coarse aggregates having positive alkali-silica reaction (ASR) shall not be used.
- (iv) The maximum value of flakiness index for coarse aggregates shall not exceed 35 percent.

8.5 Sand/Fine Aggregates

- (i) All fine aggregates shall conform to IS:383 and tests for conformity shall be carried out as per IS:2386 (Part I to VIII). The fineness modulus of fine aggregates shall be between 2.0 and 3.5.
- (ii) Before the commencement of the works, at least three samples as per IS: 2430 shall be taken for each quarry source, to ascertain the quality, suitability and fitness of the available material for use in the works and the proposal along

with a copy of test reports shall be submitted to the Independent Engineer for review and comments, if any.

- (iii) Fine aggregates having positive alkali-silica reaction shall not be used.

8.6 Water

- (i) Water for use in the works for mixing and curing shall be in conformity with Clause 302.4 of IRC:21.
- (ii) Water from each source shall be tested before the start of works and thereafter every three months and after each monsoon, till the completion of the works and proposal along with a copy of test reports shall be submitted to the Independent Engineer for review and comments, if any.

8.7 Chemical Admixtures

8.7.1 Chemical Admixtures are proprietary items and shall be obtained only from reputed manufacturers with proven track record, quality assurance and full-fledged laboratory facilities for manufacture and testing.

8.7.2 The following guidelines shall be followed in their selection and use of the admixtures:-

- (i) The chemical admixtures shall comply with IS: 9103 and meet the requirements stipulated in Clause 5.5 of IS:456.
- (ii) The admixtures generating hydrogen or nitrogen or containing nitrates, sulphides, sulphates, or any other material liable to affect the reinforcement/ embedments or concrete shall not be used.
- (iii) Compatibility of admixture with the cement being used shall be tested before actual use in the works. The test shall be repeated in case of change of type or grade or source of cement.
- (iv) Admixtures shall not impair the durability of concrete. They shall not combine with the ingredients to form harmful compounds or endanger the protection of reinforcement against corrosion.
- (v) The packing of admixtures shall clearly indicate the name of the manufacturer/ supplier, brand name (name of the product), date of production and expiry, batch/ identification number.

- 8.7.3 The Concessionaire shall obtain a Certificate from manufacturer/supplier and submit to the Independent Engineer for review and comments, if any. The Certificate shall include the following information concerning the proposed admixture;
- (i) Normal dosage with permissible range as a percentage of weight of cement and adverse effects, if any, of over and under dosage.
 - (ii) Chemical names of main ingredients.
 - (iii) Chloride content, if any, expressed as a percentage by weight of the admixture.
 - (iv) Values of dry material content with relative density of the admixture, which can be used for Uniformity Tests.
 - (v) pH value and colour.
 - (vi) Whether or not the proposed admixture leads to the entrainment of air when used as per the manufacturer's recommended dosage and if so, to what extent.
 - (vii) Where two or more admixtures are proposed to be used in any one mix, confirmation as to their compatibility.
 - (viii) Confirmation that there is no risk of corrosion of reinforcement or other embedments.
 - (ix) Latest date of test and name of the laboratory.
 - (x) Shelf life, maximum and minimum temperature for storage, precautions to be taken while mixing and any other instructions for use.
- 8.7.4 In addition to conforming to the requirements of IS:9103, the proposed admixture shall also satisfy the following conditions;
- (i) "Plasticisers" and "Super-Plasticisers" shall meet the requirements indicated for "Water reducing Admixtures".
 - (ii) The chloride content of the admixture shall not exceed 0.2 per cent by weight of admixture when tested in accordance with IS:6925.
 - (iii) Except where resistance to freezing and thawing and to disruptive action of deicing salts is necessary, the air content of freshly mixed concrete in accordance with the pressure method given in IS:1199 shall not be more than 2 percent higher than that of the corresponding control mix and in any case, not higher than 3 percent of the test mix.
 - (iv) Uniformity tests on the admixtures are essential to compare qualitatively the composition of different samples taken from batch to batch or from same batch

at different times. The tests that shall be performed along with permissible variations over the values stated by the manufacturer are given below;

- Dry Material Content: within 3 percent and 5 percent of liquid and solid admixture respectively.
 - Ash Content: within 1 percent of the value stated by the manufacturer.
 - Relative Density: within 2 percent
(for liquid admixtures)
- (v) All tests relating to the concrete admixtures shall be conducted periodically at an independent laboratory and compared with the data furnished by the manufacturer.

8.8 Steel

8.8.1 *Steel for Prestressing*

- (i) The prestressing steel shall be of any of the following types:
- (a) Plain hard drawn steel wire conforming to IS:1785 (Part-I) and IS:1785 (Part- II),
 - (b) Cold drawn indented wire conforming to IS:6003,
 - (c) High tensile steel bar conforming to IS:2090,
 - (d) Uncoated stress relieved strand conforming to IS:6006, and
 - (e) Uncoated stress relieved low relaxation steel conforming to IS:14268.
- (ii) Data in respect of modulus of elasticity, relaxation loss at 1000 hours, minimum ultimate tensile strength, stress-strain curve etc. shall be obtained from the manufacturers. Prestressing steel shall be subjected to acceptance tests prior to actual use on works. Guidance may be taken from BS:4447. The modulus of elasticity value, as per acceptance tests, shall conform to the design value, which shall be within a range not more than 5 per cent between the maximum and the minimum.

8.8.2 *Reinforcement/Untensioned Steel*

- (i) All reinforcing steel for use in works, shall be procured from original producers or their authorized agents.

- (ii) Only new steel shall be brought to the site. Every bar shall be inspected before assembling on the work and defective, brittle or burnt bars shall be discarded. Cracked ends of bars shall be cut before use.
- (iii) All reinforcement shall be free from loose rust and coats of paints, oil, mud or any other substances, which may destroy or reduce bond. The reinforcement bars bent and fixed in position shall be free from loose rust or scales, coats of paints, oil, mud or chloride contamination and other corrosion products. Where cleaning of corroded portions is required, effective method of cleaning such as sand blasting or other method shall be submitted to the Independent Engineer for prior review and comments, if any.

8.8.3 *Steel for Bearings*

Mild steel, high tensile steel, cast steel, steel forgings, and stainless steel shall conform to the provisions contained in clause 925.1 of IRC:83 (Part III).

8.8.4 *Structural Steel*

All structural steel, castings and forgings, fasteners (bolts, nuts, washers and rivets), welding consumables, wire ropes and cables shall conform to the provisions of Clauses 505.1.2, 505.2, 505.3, 505.4 and 505.6 of IRC:24 respectively.

8.9 Storage of Materials

All materials shall be stored at proper places so as to prevent their deterioration or intrusion of foreign matter and to ensure the preservation of their quality and fitness for the work. Any material which has deteriorated or has been damaged or is otherwise considered defective after review by the Independent Engineer shall not be used in the works and shall be removed from site by the Concessionaire at his cost. Such materials shall not be made acceptable by any modifications.

8.10 Reports to be submitted

The Concessionaire shall submit test results of all materials and finished products proposed to be used in the Project Highway, as specified in the QC documents, to the Independent Engineer for review and comments, if any.



Section 9

**Traffic Control Devices and
Road Safety Works**



SECTION 9

TRAFFIC CONTROL DEVICES AND ROAD SAFETY WORKS

9.1 General

- (i) Traffic control devices shall comprise of traffic signs, road markings, safety barriers, pedestrian railings, etc. Guidelines given in IRC:35, IRC:67 and Section 800 of the MOSRTH Specifications shall be followed in adopting appropriate road markings and traffic signs, unless otherwise specified in this Section.
- (ii) The Concessionaire shall also follow the guidelines and suggestions stipulated in the MOSRTH "Manual for Safety in Road Design", while designing, constructing, operating and maintaining the two-lane highway.

9.2 Road Markings

All road markings shall conform to IRC:35. Road markings shall comprise of carriageway markings such as longitudinal markings on intersections, hazardous locations, parking, etc. and object markings such as object within the carriageway, adjacent to carriageway and marking on kerbs.

9.2.1 *Material*

- (i) Hot applied thermoplastic paint with glass beads shall be used as carriageway marking materials.
- (ii) Road marking paint conforming to IS:164 shall be used for object markings.

9.2.2 *Raised Pavement Markers (Cat's Eyes):*

The cat's eyes or road studs are used to form a semi-permanent marking and provide improved visibility during night time and wet-weather conditions. These shall be either reflex lens type or solid white beads. These shall be provided at hazardous locations and while approaching important intersections, to supplement the paint or thermoplastic line markings and road stretches passing through municipal areas or village settlements and habitations.

9.3 Road Signs

There are three types of road signs viz., mandatory/regulatory signs, cautionary/warning signs, and informative signs. Locations of signs shall conform to IRC:67 and Section 800 of MOSRTH Specifications.

9.3.1 *Sheeting*

The retro-reflective sheeting shall be used on the signs. The sheeting shall be weather-resistant and show colourfastness. It shall be new and unused and shall show no evidence of cracking, scaling, pitting, blistering, edge lifting or curling and shall have negligible shrinkage or expansion. A certificate of having tested the sheeting for these properties in an unprotected outdoor exposure facing the sun for two years and its having passed these tests shall be obtained from a reputed laboratory by the manufacturer of the sheeting and shall be provided for review and comments, if any, of the Independent Engineer. The reflective sheeting shall be of High Intensity Grade with encapsulated lens or with micro prismatic retro-reflective element material as specified by the Government. The retro-reflective surface after cleaning with soap and water and in dry condition shall have the minimum co-efficient of retro-reflection (determined in accordance with ASTM Standard D 4956-04) as indicated in Tables 9.1 and 9.2.

9.3.2 *Messages/Borders*

The messages (legends, letters, numerals etc.) and borders shall either be screen-printed or of cut-outs. Screen-printing shall be processed and finished with materials and in a manner specified by the sheeting manufacturers.

For screen-printed transparent coloured areas on white sheeting, the co-efficient of retro-reflection shall not be less than 50% of the values of corresponding colour in Tables 9.1 and 9.2.

Table 9.1 : Acceptable Minimum Coefficient of Retro-Reflection for High Intensity Grade Sheeting (Encapsulated Lens Type) (Candelas Per Lux Per Square Metre)

| Observation Angle | Entrance Angle | White ^A | Yellow ^A | Green ^A | Red ^A | Blue ^A |
|-------------------|----------------|--------------------|---------------------|--------------------|------------------|-------------------|
| 0.1° ^B | -4° | 300 | 200 | 54 | 54 | 24 |
| 0.1° ^B | +30° | 180 | 120 | 32 | 32 | 14 |
| 0.2° | -4° | 250 | 170 | 45 | 45 | 20 |
| 0.2° | +30° | 150 | 100 | 25 | 25 | 11 |
| 0.5° | -4° | 95 | 62 | 15 | 15 | 7.5 |
| 0.5° | +30° | 65 | 45 | 10 | 10 | 5.0 |

^A Minimum Coefficient of Retro-reflection (R_A) ($cd \cdot lx^{-1} \cdot m^2$)

^B Value for 0.1° observation angles are supplementary requirements that shall apply only when specified by the purchaser in the contract or order.

Table 9.2 : Acceptable Minimum Coefficient of Retro-Reflection for High Intensity Micro-Prismatic Grade Sheeting (Candelas Per Lux Per Square Metre)

| Observation Angle | Entrance Angle | White ^A | Yellow ^A | Green ^A | Red ^A | Blue ^A | Fluorescent Yellow-Green ^A | Fluorescent Yellow ^A | Fluorescent Orange ^A |
|-------------------|----------------|--------------------|---------------------|--------------------|------------------|-------------------|---------------------------------------|---------------------------------|---------------------------------|
| 0.1° ^B | -4° | 500 | 380 | 70 | 90 | 42 | 400 | 300 | 150 |
| 0.1° ^B | +30° | 240 | 175 | 32 | 42 | 20 | 185 | 140 | 70 |
| 0.2° | -4° | 360 | 270 | 50 | 65 | 30 | 290 | 220 | 105 |
| 0.2° | +30° | 170 | 135 | 25 | 30 | 14 | 135 | 100 | 50 |
| 0.5° | -4° | 150 | 110 | 21 | 27 | 13 | 120 | 90 | 45 |
| 0.5° | +30° | 72 | 54 | 10 | 13 | 6 | 55 | 40 | 22 |

^A Minimum Coefficient of Retro-reflection (R_A) ($cd \cdot lx^{-1} \cdot m^2$)

^B Value for 0.1 observation angles are supplementary requirements that shall apply only when specified by the purchaser in the contract or order.

Cut out messages and borders, wherever used, shall be made out of retro-reflective sheeting (as per para 9.3.1), except those in black, which shall be non-reflective as specified by the manufacturer. The cutouts shall be bonded properly with the base sheeting in the manner specified by the manufacturer.

9.3.3 Colour Scheme

- (i) Unless specified otherwise, the general colour scheme shall be in accordance with IRC:67, the colours shall be as stipulated in IS:5 "Colour for Ready Mixed Paints".
- (ii) The colours shall be durable and uniform when seen in daylight or under normal headlights at night.
- (iii) Direction, destination and plate identification signs shall have green background and white messages (legends, letters, numerals, etc.) and borders.
- (iv) Colour scheme for facility information signs, other useful information signs and parking signs shall conform to the provisions contained in IRC:67. In respect of informatory signs, the messages/borders shall either be screen-printed or of cutouts, while for warning and regulatory signs, these shall be screen-printed.

- (v) Clustering and proliferation of road signs shall be avoided for enhancing their effectiveness.

9.3.4 *Adhesives*

The sheeting shall either have a pressure-sensitive adhesive of the aggressive tack requiring no heat, solvent or other preparation for adhesion to a smooth clean surface, or a tack free adhesive activated by heat applied in a heat-vacuum applicator, in a manner recommended by the sheeting manufacturer. The adhesive shall be protected by an easily removable liner (removable by peeling without soaking in water or other solvent) and shall be suitable for the type of material of the base plate used for the sign. The adhesive shall form a durable bond to smooth corrosion and weather resistant surface of the base plate such that it shall not be possible to remove the sheeting from the sign base in one piece by use of sharp instrument. In case of pressure sensitive adhesive sheeting, the sheeting shall be applied in accordance with the manufacturer's specifications. Sheeting with adhesives requiring use of solvents or other preparation for adhesive shall be applied strictly in accordance with the manufacturer's instructions.

9.3.5 *Installation*

The sign posts, their foundations and sign mountings shall be so constructed as to hold them in a proper and permanent position against the normal storm wind loads. Normally, signs with an area upto 0.9 sqm shall be mounted on a single post, and for greater area two or more supports shall be provided. Sign supports may be of mild steel (MS), reinforced concrete or Galvanized Iron (GI). Post end(s) shall be firmly fixed to the ground by means of properly designed foundation. The work of foundation shall conform to relevant IRC/CPWD/PWD Specifications.

All components of signs and supports, other than the reflective portion and GI posts shall be thoroughly descaled, cleaned, primed and painted with two coats of epoxy paint. Any part of MS post below ground shall be painted with three coats of red lead paint.

The signs shall be fixed to the posts by welding in the case of steel posts and by bolts and washers of suitable size in the case of reinforced concrete or GI posts. After the nuts have been tightened, the tails of the bolts shall be furred over with a hammer to prevent removal.

Important informatory signs such as approaching important locations, like Toll Plaza, major town shall be mounted on gantries, in the form of overhead signs.

9.3.6 *Warranty and Durability*

The Concessionaire shall obtain from the manufacturer a seven year warranty for satisfactory field performance including stipulated retro-reflectance of the retro-reflective sheeting of high intensity grade and submit the same to the Independent Engineer for review and comments, if any.

9.4. Roadside Safety Barriers

There are two types of safety barriers viz., longitudinal roadside safety barriers and median safety barriers.

9.4.1 *Warrants*

The longitudinal roadside barriers are basically meant to shield two types of roadside hazards i.e. embankments and roadside obstacles and also for preventing the vehicles veering off the sharp curves. The warrants for a fill section in terms of the height and slope needing protection with roadside barriers are shown in Fig.9.1. The barrier is not warranted for embankment having a fill slope of 3: 1 or flatter. The warrants for roadside objects are mainly dependent upon the type of obstacle and the probability of their being hit. A barrier shall be installed only if the result of vehicle striking the barrier is likely to be less severe than the severity of accident resulting from the vehicle impacting the unshielded obstacle. Some of the commonly encountered roadside obstacles are bridge piers, abutments and railing ends, roadside rock mass, culverts, pipes and headwalls, cut slopes, retaining walls, lighting supports, traffic signs and signal supports, trees and utility poles.

9.4.2 *Types of Roadside Safety Barriers*

There are broadly three types of longitudinal roadside safety barriers:

- (a) Flexible type (like wire-rope fencing)
- (b) Semi Rigid type, like
 - (i) "W" beam type steel barriers
 - (ii) Thrie beam type steel barriers

These steel barriers are of strong post type and usually remain functional after moderate collisions, thereby eliminating the need for immediate repair.

- (c) Rigid type (like concrete crash barriers)

9.4.3 *Roadside Steel Barriers*

- (i) Design Aspects: The "W" beam type safety barrier consists of a steel post and 3 mm thick "W" beam rail element which is spaced away from the posts. The spacer minimizes vehicular snagging and reduces the likelihood of a vehicle vaulting over the barrier. The steel posts and the blocking out spacer shall both be channel section of 75 mm x 150 mm size and 5mm thick. The rail shall be 700 mm above ground level and posts shall be spaced 2 m center to center. Typical details are shown in Fig. 9.2.

The thrie beam safety barrier shall have posts and spacers similar to the ones mentioned above for "W" beam type. The rail shall be placed 850 mm above the ground level. This barrier has higher initial cost than the "W" beam type but is less prone to damages due to vehicle collisions especially for shallow angle impacts. Typical details of thrie beam barrier are shown in Fig. 9.3.

The "W" beam, the thrie beam, the posts spacers and fasteners for steel barriers shall be galvanized by hot dip process.

- (ii) End treatment for steel barrier: An untreated end of the roadside barrier can be hazardous, if hit, because the barrier beam can penetrate the passenger compartment and cause the impact vehicle to stop abruptly. End treatments should therefore form an integral part of safety barriers. End treatment should not spear vault or roll a vehicle for head-on or angled impacts. The two end treatments recommended for steel barriers are "Turned down guardrail and Anchored in back slope".

Turned down guardrails have the "W" or thrie sections, reduced from full height to ground level, with a gentle slope over a distance of 8 to 9 m. The turned down rail is intended to collapse on impact, allowing the vehicle to pass over it without becoming airborne or unstable. In order to locate the barrier terminal away from the travelled way and to minimize driver's reaction to a hazard near the road, by gradually introducing a parallel barrier installation or to transition a roadside barrier nearer the roadway, such as a bridge parapet or a railing, the turned down rail should be flared away from the roadway. Suggested flare rates depend upon the design speed and the type of barrier (Table 9.3).

Table 9.3 : Flare Rates

| Design speed in km per hour | Flare Rates | |
|-----------------------------|----------------|---------------------|
| | Rigid barriers | Semi-rigid barriers |
| 100 | 17:1 | 13:1 |
| 80 | 14:1 | 11:1 |
| 65 | 11:1 | 9:1 |
| 50 | 8:1 | 7:1 |
| 40 | 8:1 | 7:1 |
| 30 | 8:1 | 7:1 |

The posts in the end treatment should have the same cross sections as provided in the main barrier.

At road cross-sections in cutting or if the road transitions from cut to fill, the safety barriers can be anchored in back slopes. The back slope covering the anchored portion of the barrier should be graded flat with side slopes preferably not steeper than 10:1. The anchored portion should develop a tensile strength in the rail element to prevent the rail from pulling out of the anchorage. The barrier can also be anchored in an earth berm specially constructed for this purpose, provided the new berm itself is not a hazard to the traffic. The earth berm should be made impervious to erosion.

- (iii) **Placement:** Placement recommendations determine the exact layout of the barrier and should be made keeping in view the lateral offset of the barrier and flare rate. The final layout shall be a site-specific combination of these factors. The barriers should be as far away from the traffic as possible and should preferably have uniform clearance between the traffic and the hazard.

As far as possible, the safety barrier should be placed beyond 2.5 m of the travelled way. For long and continuous stretches, this offset is not critical. The distance between the barrier and the hazard should not be less than the deflection of the barrier by an impact of a full sized vehicle. In case of embankments, a minimum distance of 600 mm should be maintained between the barrier and the start of embankment slope of a hazard to prevent the wheels from dropping over the edge. Typical details are shown in Fig. 9.4.

Flatter flare rates may be used, particularly where extensive grading would be required to ensure a flat approach from the travelled way, subject to the availability of right of way.

9.4.4 *Roadside Concrete Barriers*

- (i) **Design Aspects:** Roadside concrete safety barriers are rigid barriers having a sloped front face and a vertical back face. The recommended designs of the cast in-situ and pre-cast barriers are shown in Figs.9.5 and 9.6 respectively. Based on evaluation of vehicle direction, sight distance, structural stability and the psychological effect of barrier height on driver reaction, the most desirable height of the median barrier is 800 mm. Variations upto 50 mm in height of barrier can be made in the total height of the barrier to meet the site requirements. It is, however, important to maintain the height of lower slope between 200 mm and 350 mm so as to reduce the chances of overturning of the vehicles.

The concrete barrier may be pre-cast in lengths up to 6 m, depending upon the feasibility of transport and lifting arrangements. Concrete grade for the barriers should not be leaner than M30. The minimum thickness of foundations shall be 25 mm cement concrete or hot mix asphalt placed at the base of barrier, to provide lateral restraint. Where more than 75 mm thick overlay on the road pavement is anticipated, the foundation step may be increased to 125 mm. However, longitudinal roadside concrete barrier should have elaborate footing design which is structurally safe, unless sufficient earth support is available.

- (ii) **End Treatment:** Safety barrier shall be provided with an end treatment, which shall be obtained by tapering the height of terminating end of the median barrier within a length of 8 m to 9 m.
- (iii) **Placement:** Placement recommendations for roadside steel barriers, given in para 9.4.3 above, are applicable to concrete barriers as well.

9.4.5 *General*

- (i) Raised curbs or drains shall not be provided between the travelled way and the barriers. These destabilize the vehicle balance and disturb its equilibrium before it strikes the barrier, thus defeating the essential purpose of safety and redirection of the impacting vehicle.
- (ii) In rural situations, both the roadside and the median barriers shall preferably be steel barriers. Concrete barriers shall be preferred in urban situations.

9.5 Safety during Construction

Widening of an existing road requires special attention to traffic diversion, traffic management and road safety. A proper Traffic Management Plan during construction shall be formulated by the Concessionaire as per guidelines given in IRC:SP:55 and submitted to the Independent Engineer for review and comments, if any. The Traffic Management Plan during construction shall be put in place before the start of any construction activity.

The execution of work shall be so planned that the inconvenience to the traffic is minimal. The temporary diversion, where constructed, shall conform to the following minimum standards:

- (i) Width of diversion road shall be equal to the width of the existing carriageway but not less than 5.5 m.
- (ii) The crust composition shall be of 150 mm GSB + 150 mm WBM + 20 mm Mixed Seal Surfacing.

9.6 Design Report

The Concessionaire shall submit proposals for traffic control devices and road safety works together with drawings and details to the Independent Engineer for review and comments, if any. The proposals shall include:

- (i) Details covering type, location, material specifications, installation details and the requisite warranties for satisfactory field performance (as applicable) in respect of road signs, road markings and roadside safety barriers;
- (ii) Traffic Management Plan during construction in accordance with the requirement specified in para 9.5 above.

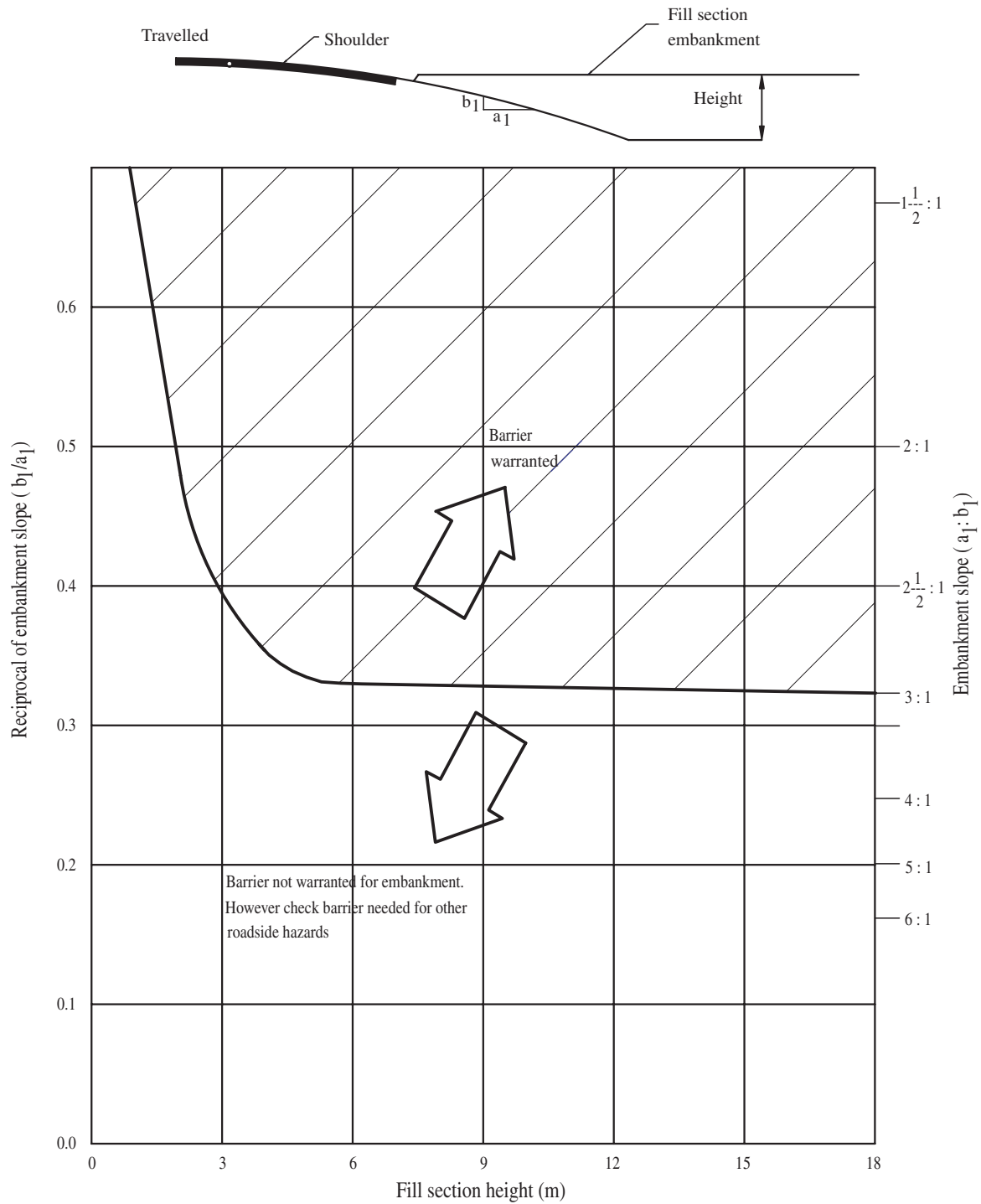
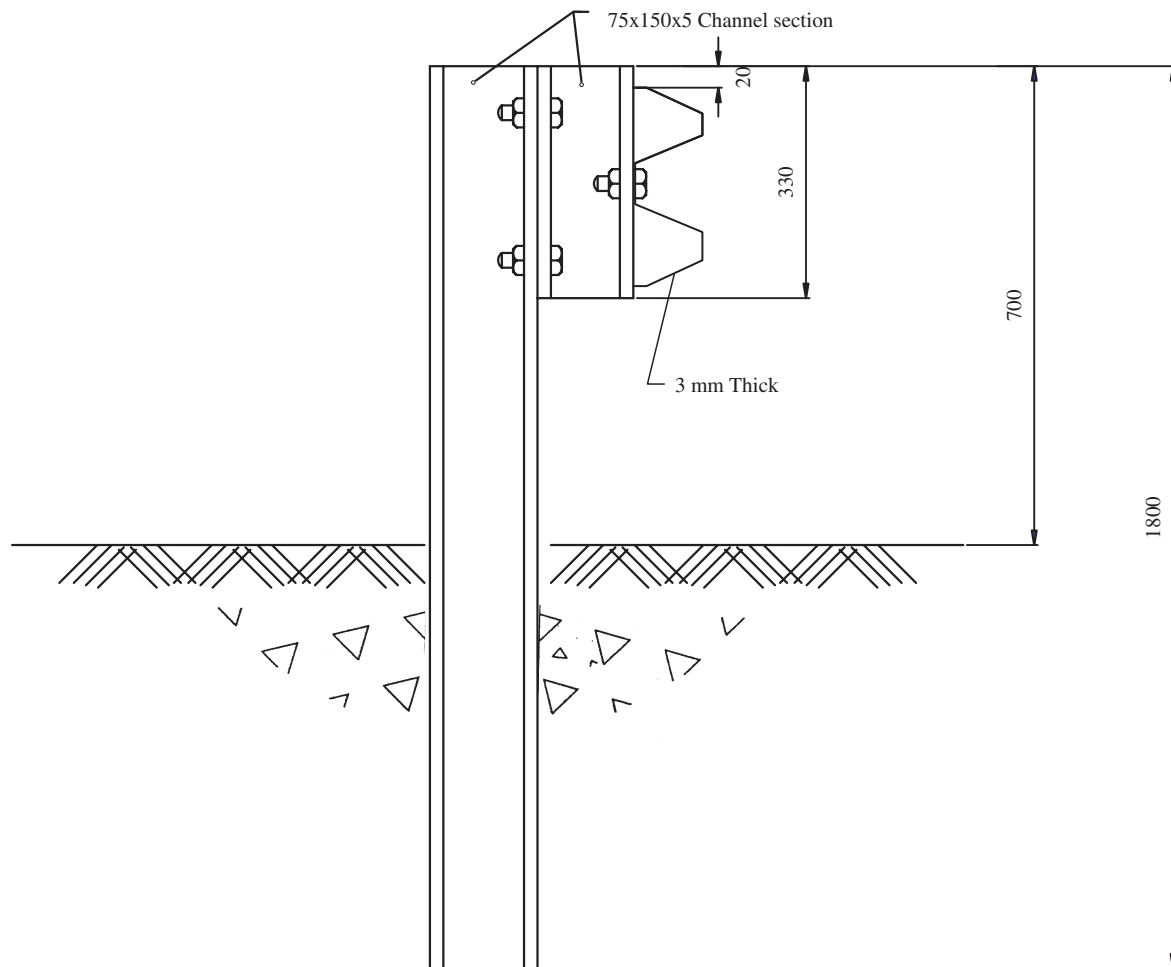
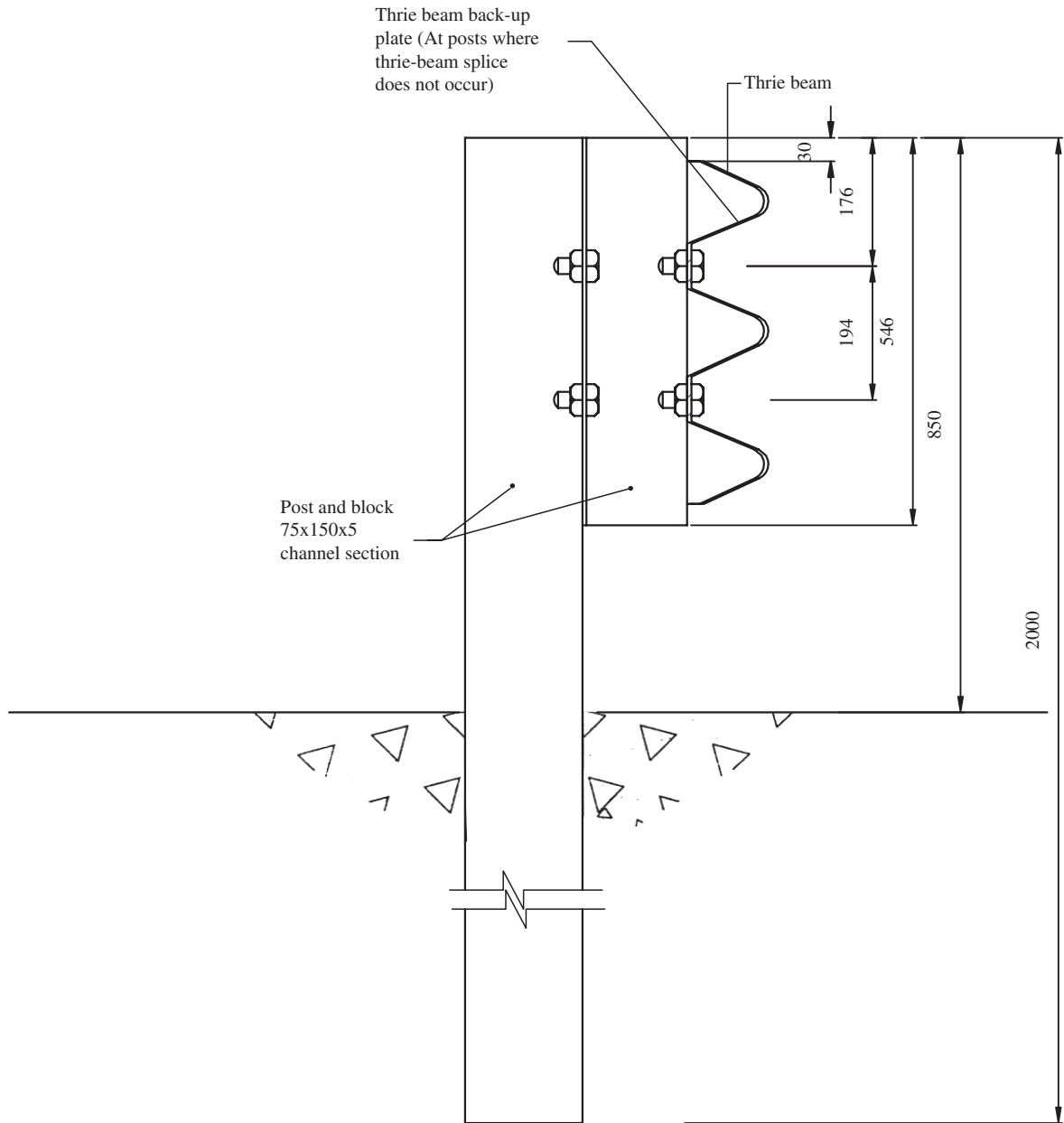

Fig. 9.1 : Warrants for roadside barriers on embankments



Note:
All dimensions are in mm.

Fig. 9.2 : Typical details of "W" beam section



Note:
All dimensions are in mm.

Fig. 9.3 : Typical details of thrie beam section

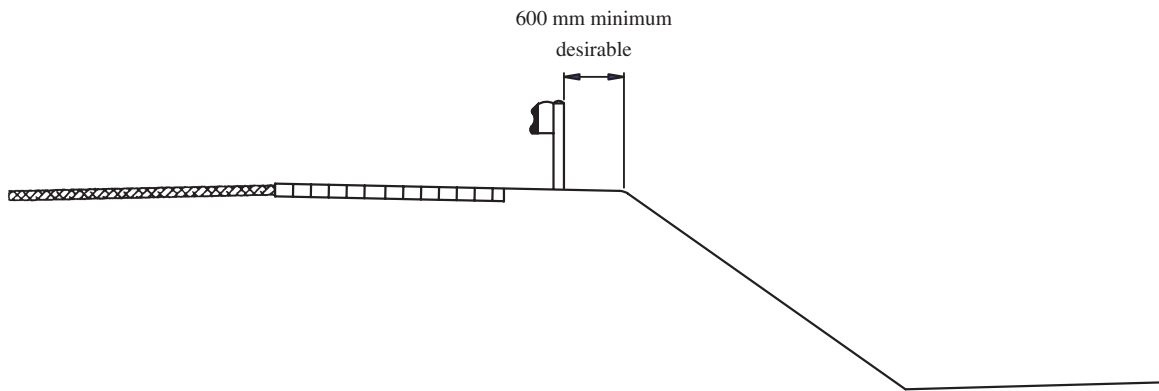
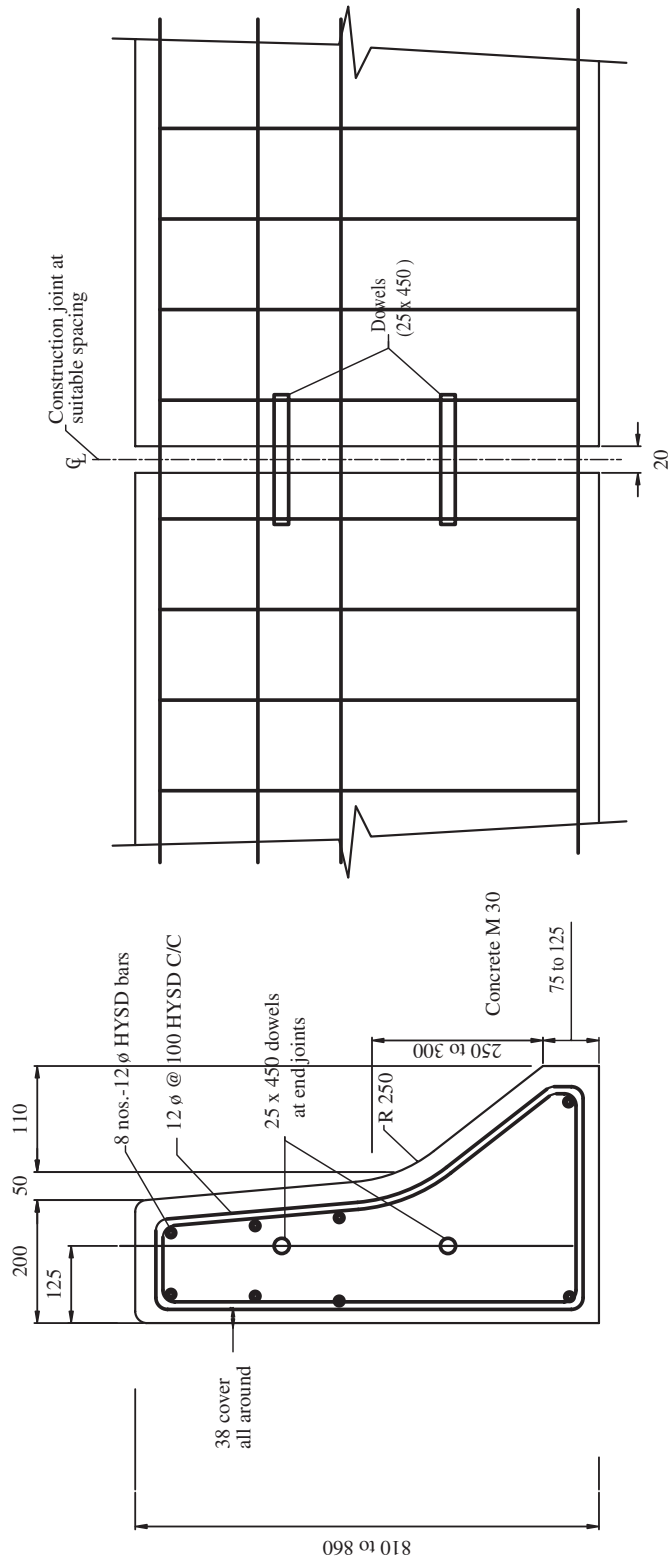

Fig. 9.4 : Recommended barrier placement



Note:

1. HYSD-High yield strength deformed reinforcement.
2. All dimensions are in mm.

Fig. 9.5 : Side barrier cast-in-situ design

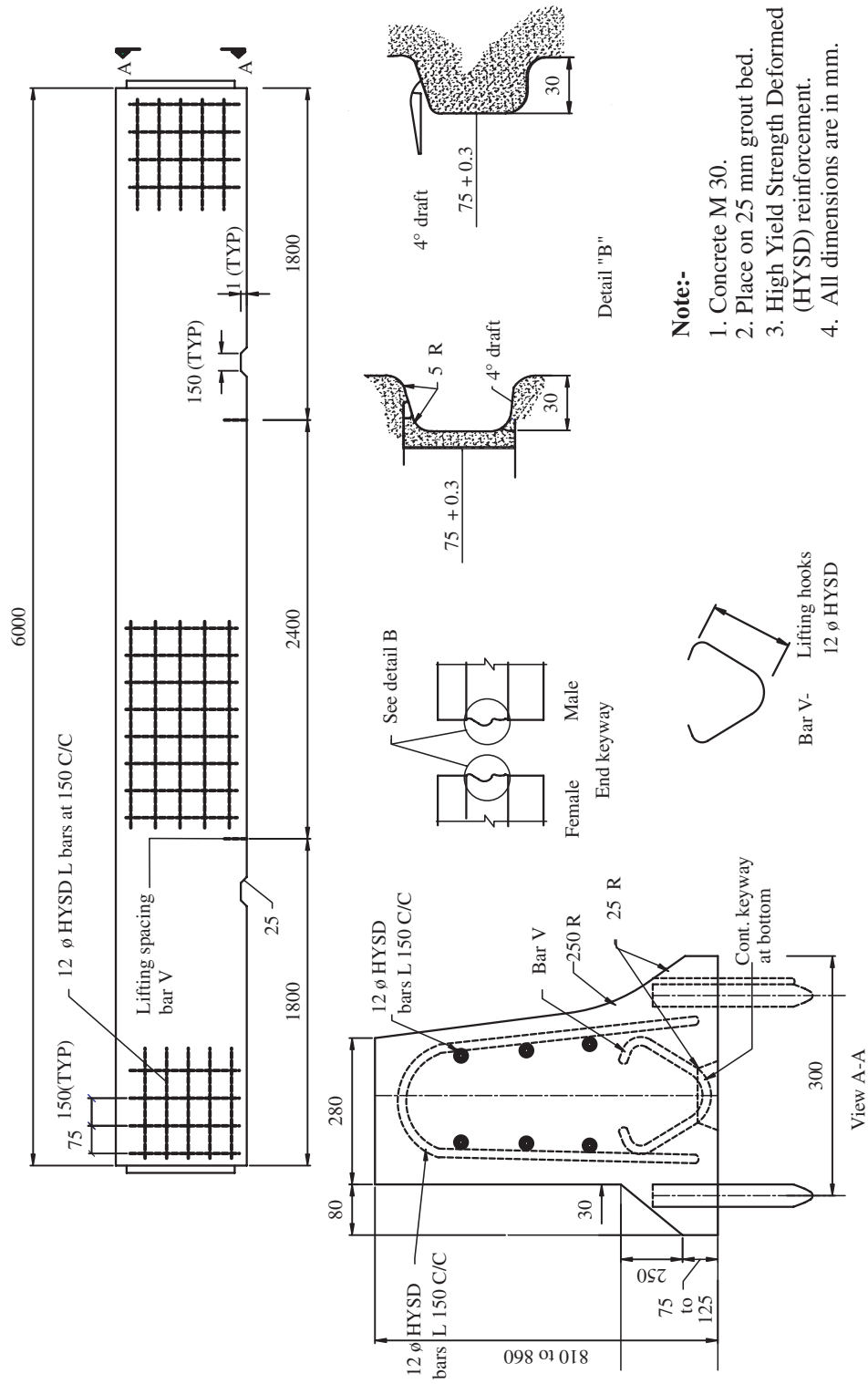

Note:-

1. Concrete M 30.
2. Place on 25 mm grout bed.
3. High Yield Strength Deformed (HYSD) reinforcement.
4. All dimensions are in mm.

Fig. 9.6 : Side barrier precast design



Section 10
Toll Plazas



SECTION 10

TOLL PLAZAS

10.1 General

The Concessionaire shall provide required number of Toll Plazas for collection of toll as per the Concession Agreement. The fee collection system shall be speedy, efficient and user friendly. The design of the Toll Plazas should be such that they are aesthetically pleasing and efficient and the fee collection staff should be quick, courteous and adequately trained before deployment.

10.2 Location of Toll Plaza

The location of Toll Plaza shall be indicated in Schedule-C of the Concession Agreement. Their locations shall be decided keeping in view the following factors:

- (i) Land availability,
- (ii) Stream of traffic on Toll Plaza,
- (iii) Visibility for the approaching traffic,
- (iv) Reasonably away from road intersections and/or rail crossings,
- (v) Free from risk of flooding and submergence, etc.

10.3 Land for Toll Plaza

Adequate land for Toll Plaza shall be acquired to permit the provision of a minimum number of 8 toll lanes including all other buildings and structures to be accommodated at the Toll Plaza location. Land shall be acquired by the Government at its own cost. However, the Government may, if so specified, require the Concessionaire to procure the same on behalf of the Government.

10.4 Lay out and design of Toll Plaza

10.4.1 Stage construction of Toll Plaza in respect of number of toll lanes shall be allowed. However, other structures as envisaged in the Concession Agreement shall be provided at the initial stage itself.

10.4.2 *General Lay Out*

- (i) Lane width = 3.2 m in general and 4.1 m for oversize vehicles.

- (ii) Median (a) Width = 1.8 m (b) Length = 50 m
- (iii) Transition - 1 in 10 may be provided from two-lane section to the widened width at Toll Plaza on either side.
- (iv) Provision for future expansion: The office building shall be located taking into consideration the future expansion.

Typical layout plan of 2+2 Toll Plaza is given in Fig. 10.1.

10.4.3 Number of Lanes at Toll Plaza

The number of lanes at the Toll Plaza in initial stage should be corresponding to the forecast traffic for at least 5 years.

Forecast traffic — Forecast traffic in terms of vehicles/day for the vehicles classified under tollable category. Non-tollable vehicles need not be considered for calculation of number of toll lanes, as they would be allowed to pass through a separate lane.

Peak hour factor — Percentage of traffic travelling during peak hour to average daily traffic.

The number of toll lanes for the Toll Plaza may be derived using Table 10.1.

**Table 10.1 : Number of toll lanes in each direction
(Semi Automatic toll gates)**

| Forecast Traffic (in vehicles/day) total of both directions | Peak Hour Factor | | | |
|---|------------------|----|----|----|
| | 6% | 7% | 8% | 9% |
| Less than 7,000 | 2 | 2 | 2 | 2 |
| 7,000-12,000 | 2 | 2 | 3 | 3 |
| More than 12,000 | 3 | 3 | 4 | 4 |

10.4.4 If at any time, the queue of vehicles becomes so large that the waiting time of the user exceeds three minutes, the number of toll lanes shall be increased so that the maximum waiting time is brought down to less than three minutes.

10.4.5 *Toll Collection System*

A minimum semi-automatic system for toll collection shall be adopted. In this system, the collection of tolls and recording data would be made through electronic equipment. Within a period of 5 years from COD, at least one booth for either side traffic shall be upgraded to toll collection with the help of smart card.

For smooth and efficient functioning of toll collection, the following arrangements/facilities shall be provided:

- (i) The staff posted at the counters shall be provided with sufficient equipment and small denomination notes/coins at the start of each shift.
- (ii) Intercom facility shall be provided between booths and the office of the Supervisors.
- (iii) If any booth is closed for any reason, incoming traffic shall be guided into the adjoining working booth with the help of appropriate signs.
- (iv) The entire fee collection complex shall be adequately guarded.

10.4.6 *Vehicle Counting Classifier (VCS) Unit*

Each lane shall be equipped with micro-controller based vehicle counting and classifier and battery backup to collect data in the case of power failure.

10.5 Toll Booths

Toll booths may be provided of prefabricated materials or of brick masonry. The toll booths shall have adequate space for seating of toll collector, computer, printer, cash box, etc. It should have provision for light, fan and air conditioning. The typical details of toll booth are given in Fig. 10.2.

10.6 Road works

Vehicles are required to decelerate while entering the toll lane, stop for payment and then accelerate and merge in the main line traffic of the highway. All these operations of vehicles at Toll Plaza are prone to oil/POL spillage on the surface, which may have cut-back action on bituminous surface. Therefore, concrete pavement would be preferred in the Toll Plaza area including tapering zone, from durability and long term serviceability consideration. The rigid pavement shall be designed as per IRC:58. For this work, use of paver shall not be insisted.

10.7 Traffic Signs

- 10.7.1 A well thought out strategy should be evolved for providing traffic signs at the Toll Plaza, in accordance with IRC:67.
- 10.7.2 Signs should be placed along the Project Highway, roadway of Toll Plaza to guide and render assistance to the drivers approaching Toll Plaza. It is necessary to remind the driver about the existence of Toll Plaza one km ahead with a repeater sign 500 m ahead. Stop sign shall always be used in combination with certain road markings such as stop line and the word 'STOP' marked on the pavement.
- 10.7.3 The Toll Plaza sign should be supplemented by the sign advising the users of the notified toll rates for various types of vehicles. Typical details of road signs required for toll purpose are given in Figs. 10.3 to 10.8.

10.8 Road Markings

- 10.8.1 The road markings shall be in accordance with Section 9 of this Manual. The road markings for the Toll Plaza area shall consist of lane markings, diagonals, chevron markings. Single centre line is provided at the centre of carriageway at toll gate to demarcate each service lane. Diagonal markings for central traffic island and chevron markings at side traffic island shall be provided to guide the approaching and separating traffic.
- 10.8.2 The road markings shall be in accordance with provision of IRC:35. Thermoplastic paint with reflective glass beads shall be used as road marking material. Typical details of road markings at Toll Plaza are given in Fig 10.9.

10.9 Toll Plaza Complex

- 10.9.1 The size of the office complex depends on the minimum requirement of facilities such as toilet, bathroom, store, rest room, traffic aid post, medical aid post, etc. All these depend on the size of Toll Plaza and may vary as per the need of a particular location/ area.
- 10.9.2 The following facilities shall be provided at Toll Plaza complex:-
- (i) Office complex with toilet, bathroom and rest room.
 - (ii) Traffic aid post (refer Section-13)
 - (iii) Medical aid post (refer Section-13)

10.10 Check/Barrier Gate

A boom barrier is generally placed at the exit of each lane to avoid passing of any vehicle without payment of toll. Electrically operated barrier gates shall be used.

10.11 Lighting

10.11.1 The Toll Plaza complex shall have continuous and reliable electric supply system for efficient functioning.

10.11.2 *Interior Lighting*

The toll booths and facility building office shall be illuminated adequately. Indoor lighting should be with fluorescent lamps. Lighting should be provided in such a manner that glare is avoided or minimised. The level of illumination shall be 200 to 300 Lux as per IS:3646 (Part II).

10.11.3 *Exterior Lighting*

Lighting of the Toll Plaza is important for enhancing the night visibility. The lighting system shall consist of the following major components:

- (i) High Mast lighting.
- (ii) Lighting on both side approaches to the Toll Plaza.
- (iii) Canopy lighting of complex.
- (iv) Back up arrangement in case of power failure.
- (v) Highway lighting around Toll Plaza.

10.11.4 *High Mast Lighting*

IS:1944 (Part I & II) recommends 30 Lux of average illumination on road surface and ratio of minimum to average illumination as 0.4. Normal low light poles are not able to give the required lighting conditions. It is, therefore, necessary to install high mast. The 30 m height of the mast is considered suitable to have uniform spread of desired level of illumination in the Toll Plaza area for frequent and safe movement of vehicles.

10.11.5 *Highway Lighting*

Lighting in 100 m length on both side approaches of Toll Plaza shall be provided to enhance the safety on highway and to make the drivers conscious of their approaching the toll gate.

10.11.6 *Canopy Lighting*

A higher level of illumination upto 100 Lux by providing 150-watt metal halide lamps shall be provided at the toll gate and at toll booth locations. 1000-watt halogen lamps shall be provided at the selected nodes of space frame of the canopy to ensure uniform illumination of the area.

10.12 Water Supply

Adequate water supply shall be provided. For working out water requirement and internal drainage system, reference may be made to IS:1172, IS:5339 and IS:1742.

10.13 Fire Fighting System

For protection of the Toll Plaza complex against fire hazards, adequate fire protection arrangements shall be made.

10.14 Report to be submitted

The design and layout of Toll Plaza complex, including all facilities shall be submitted to the Independent Engineer for review and comments, if any.

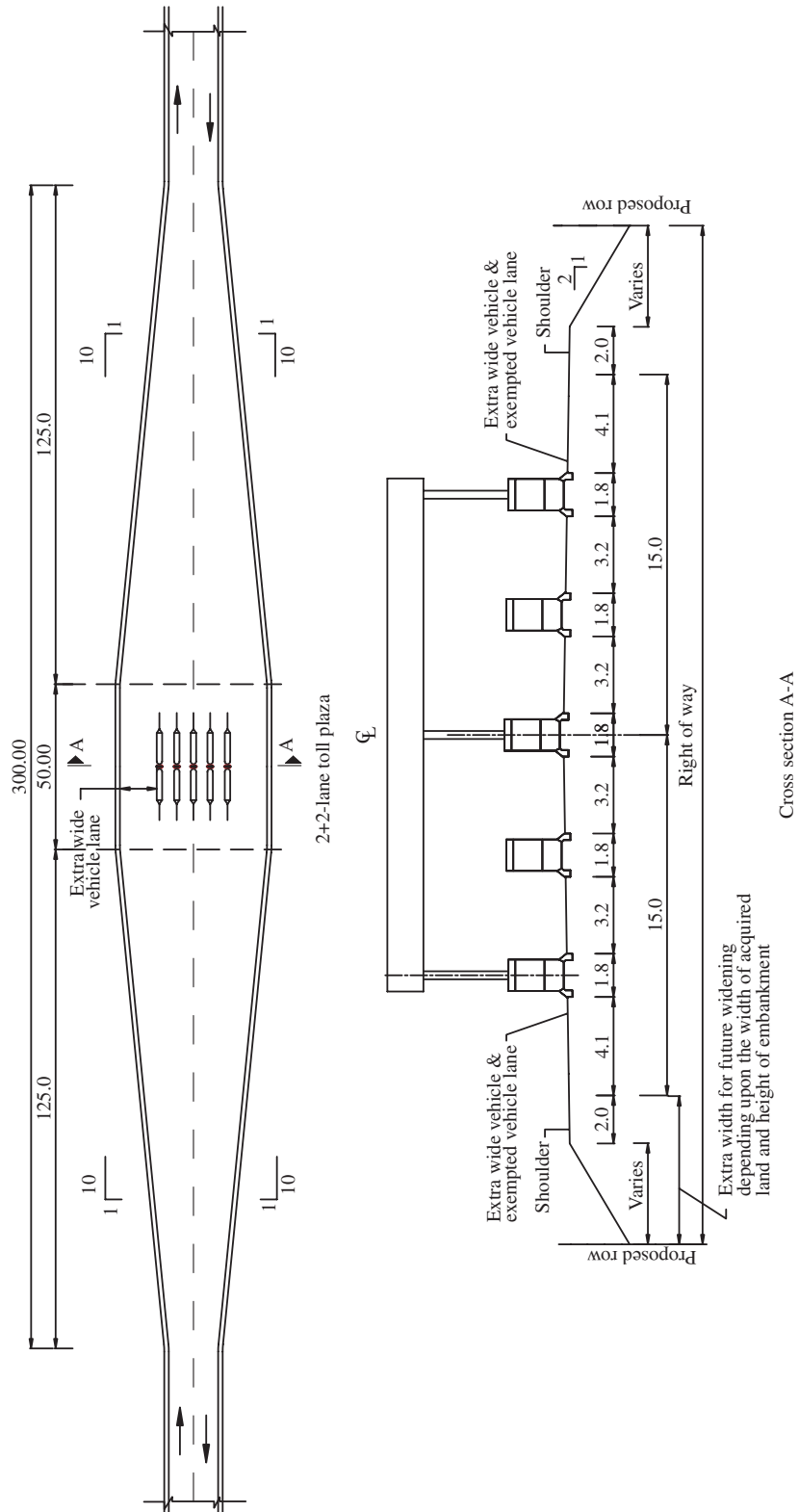

Note:
All dimensions are in metres.

Fig. 10.1 : General layout 2+2-lane toll plaza

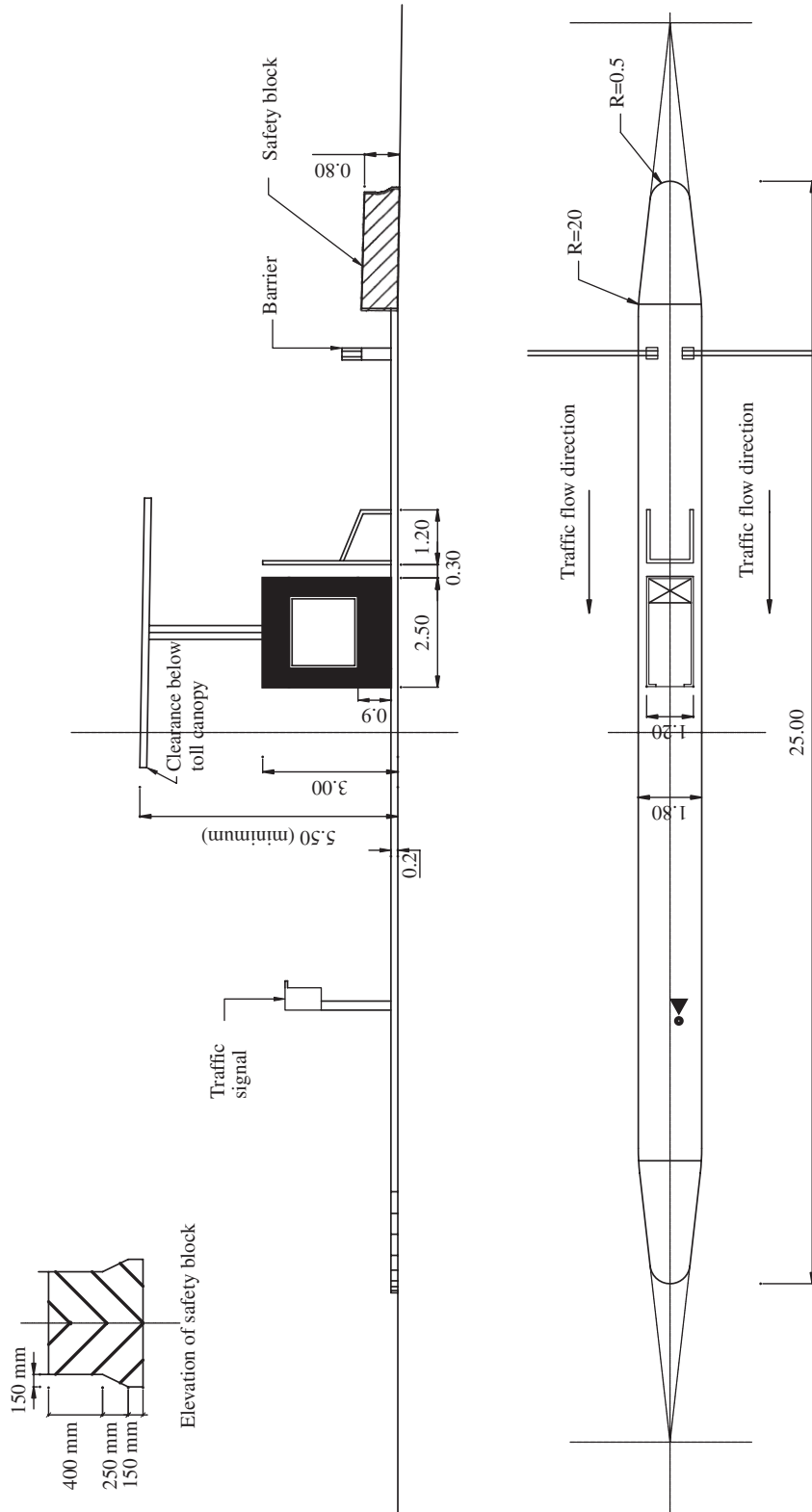

Note:
All dimensions are in metres.

Fig. 10.2 : Recommended layout for traffic island with toll booth

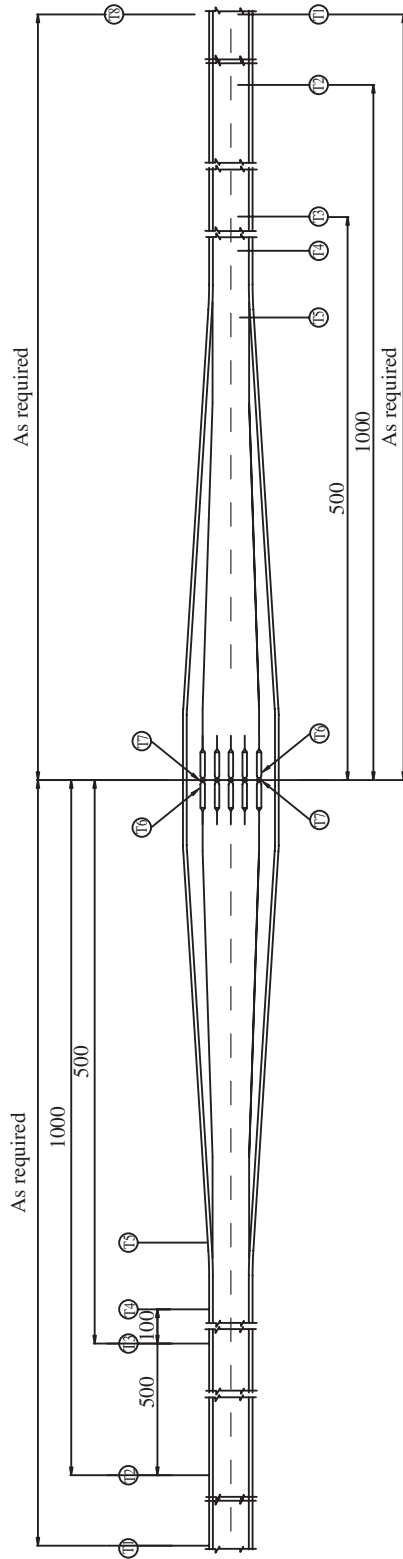

Toll related signs on highway

- (T1) Cantilever gantry sign for Toll Road start
- (T2) Cantilever gantry sign for Toll Gate 1.0 km
- (T3) Kerb sign for Toll Gate 500 m and toll rates
- (T4) Kerb sign for exempt vehicles
- (T5) Kerb sign for pictorial depiction of toll rates
- (T6) Kerb sign for exempt and over size vehicles lane direction sign
- (T7) Sign near the tollbooths displaying toll rates, exempt vehicles and complaint telephone number & address
- (T8) Cantilever gantry sign for toll road ends

Note:

1. Generally road signs shall be in accordance with IRC 67-2001.
2. All dimensions are in metres.

Fig. 10.3 : Signages

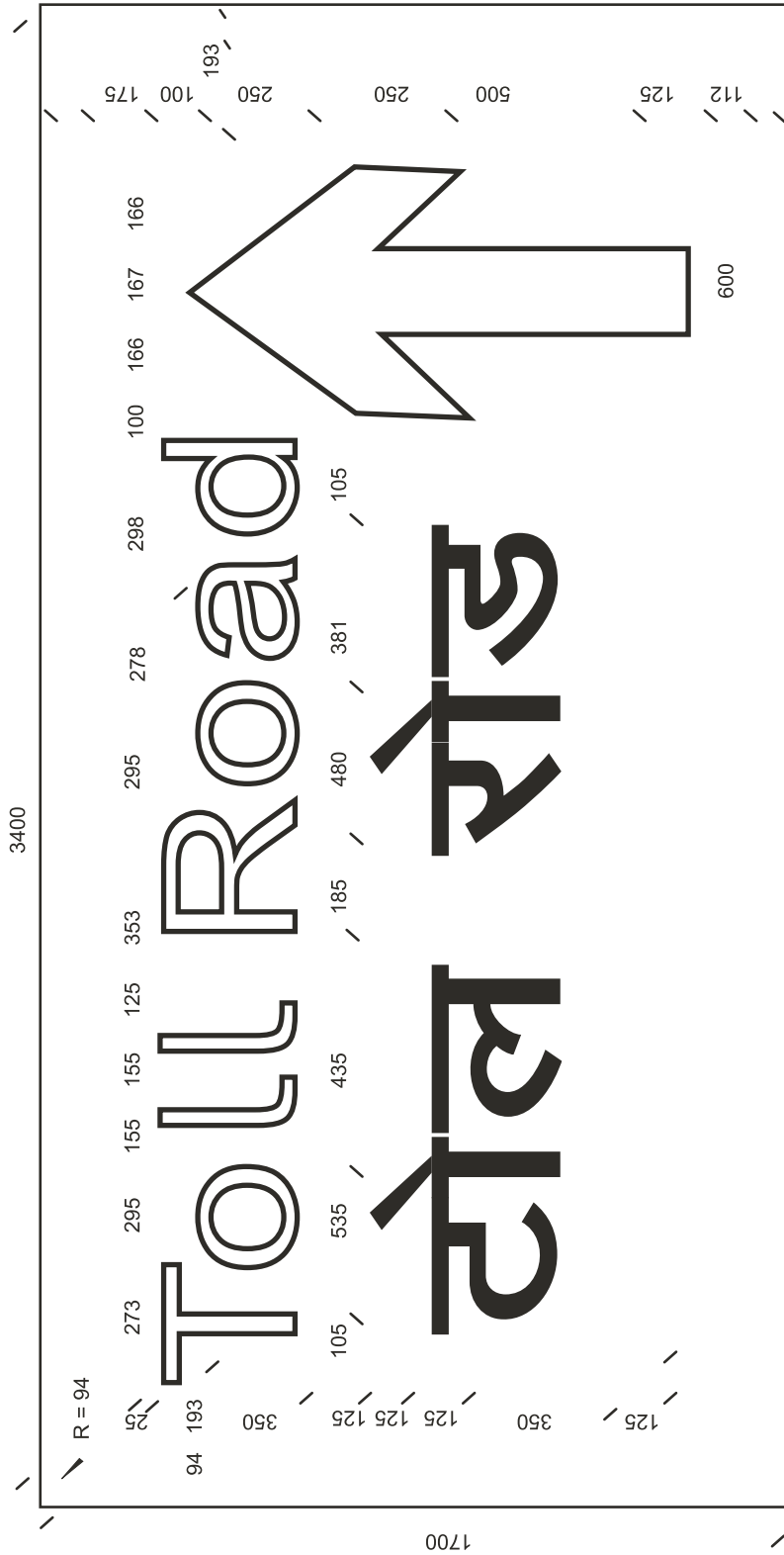

Note:
All dimensions are in mm.

Fig. 10.4 : Overhead direction sign for toll road

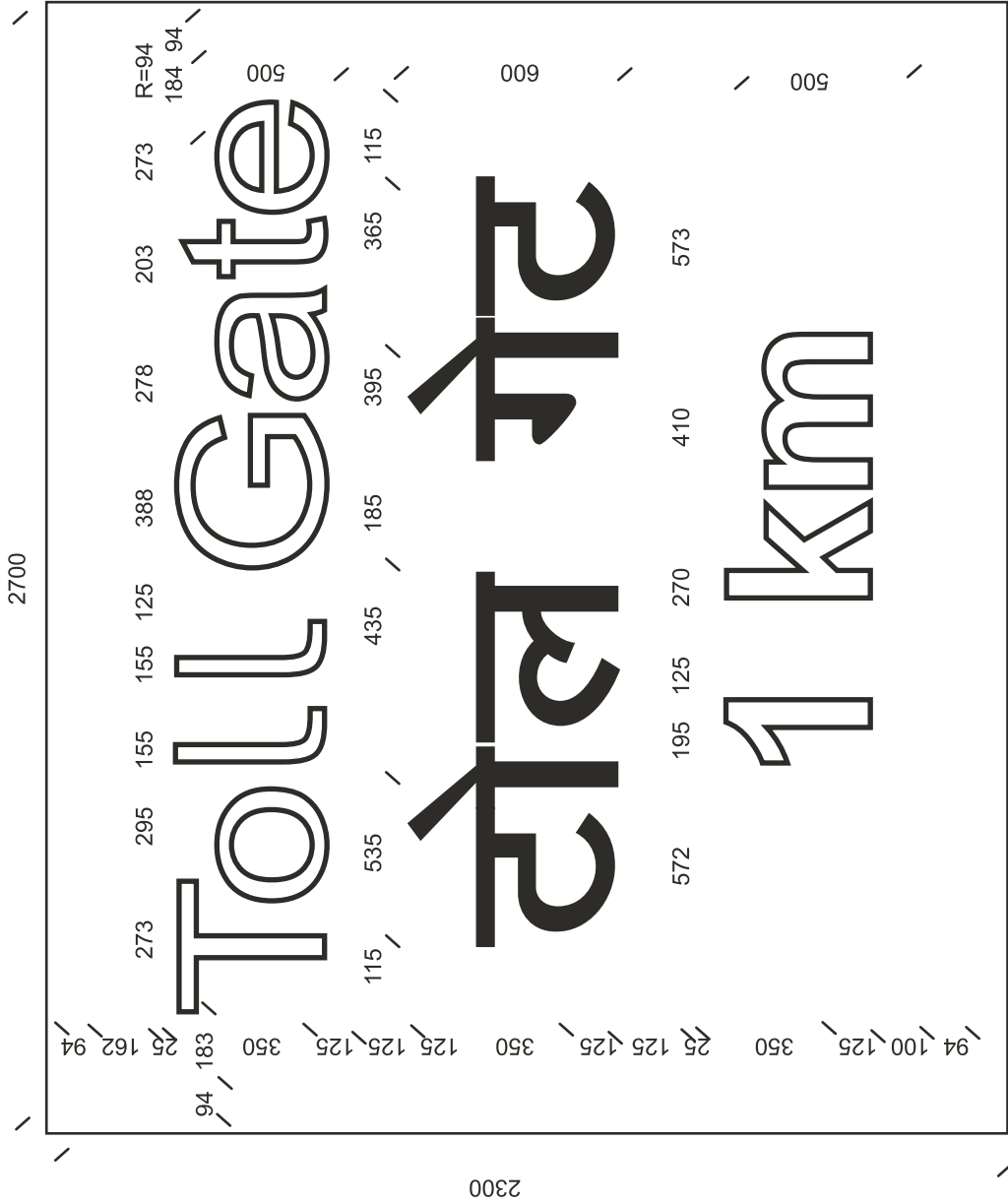

Note:
All dimensions are in mm.

Fig. 10.5 : Overhead sign for toll gate

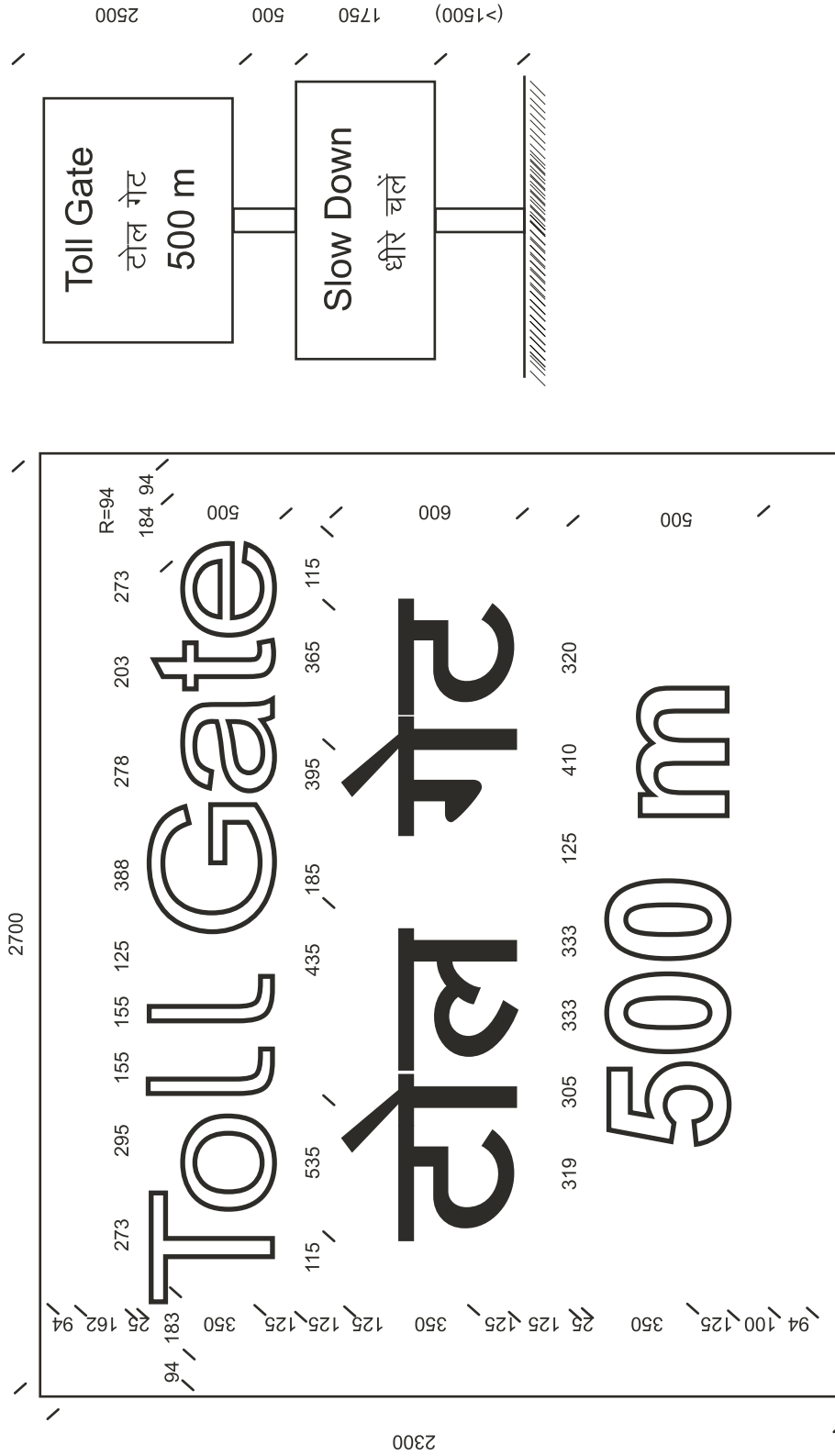
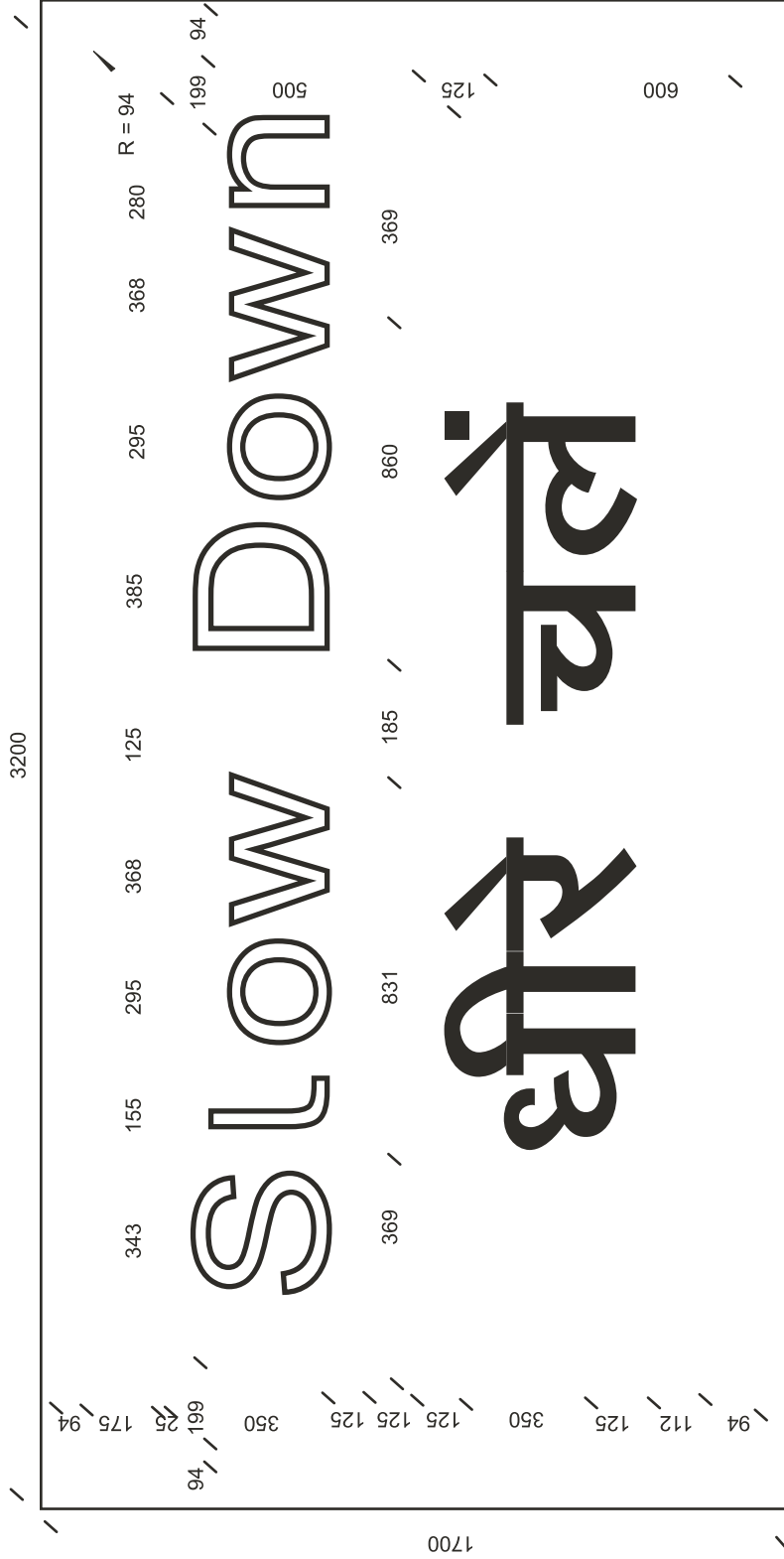
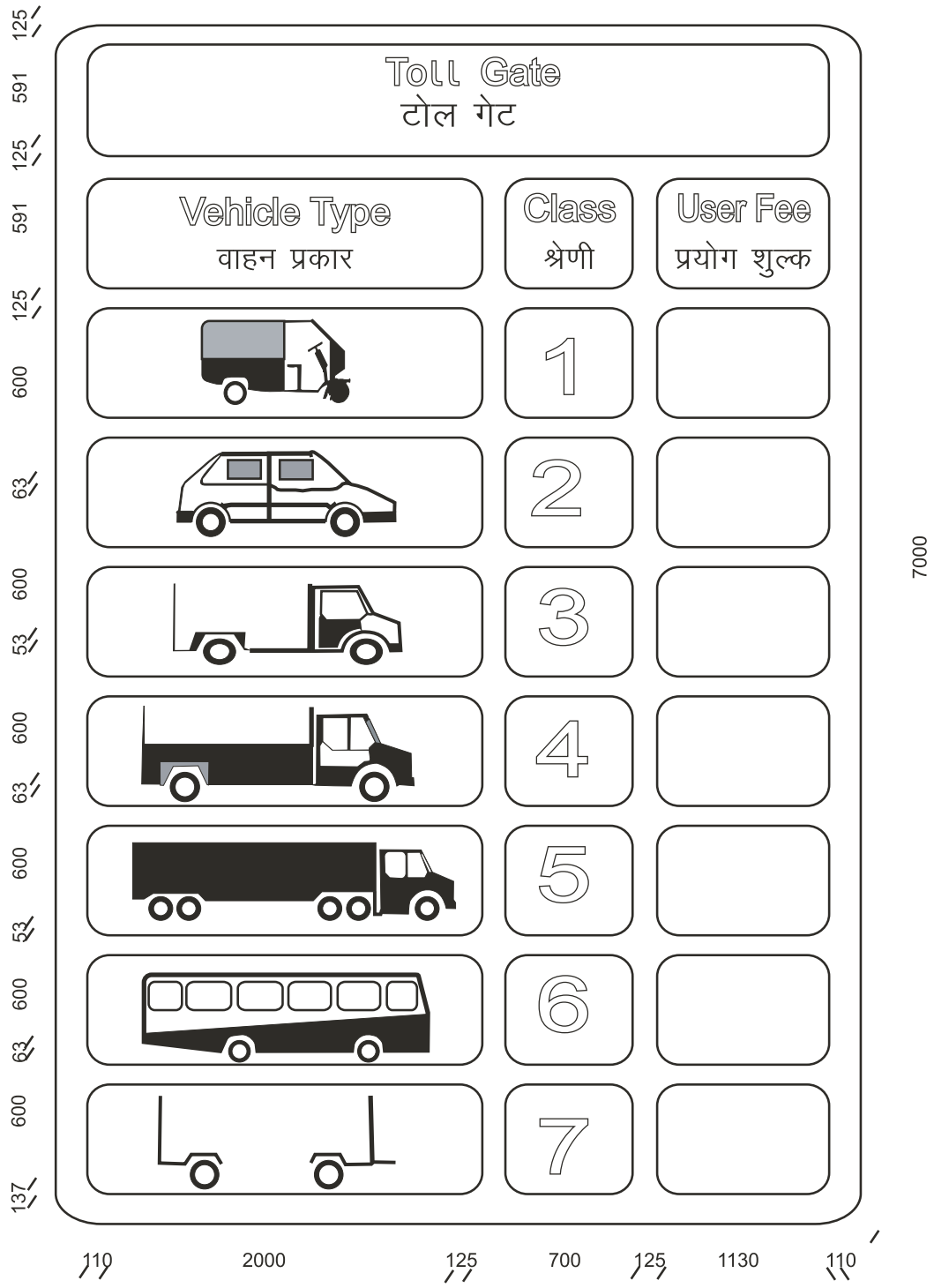

Fig. 10.6 : Side mounted sign for toll gate (upper panel)



Note:
All dimensions are in mm.

Fig. 10.7 : Side mounted sign for toll gate (lower panel)



Note:
All dimensions are in mm.

Fig. 10.8 : Recommended sign layout for toll rates (side mounted)

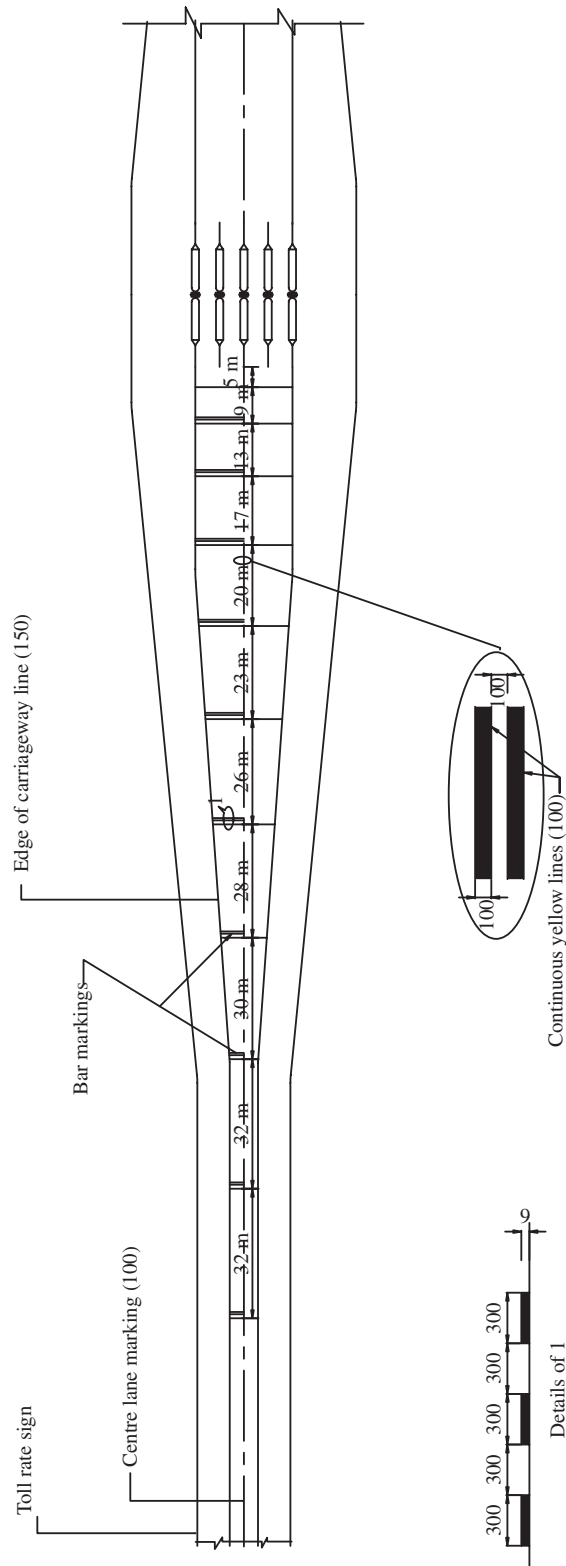

Note:

1. Generally pavement marking shall be in accordance with IRC 35-1997.
2. All dimensions are in mm unless otherwise specified.

Fig. 10.9 : Pavement markings



Section 11
Roadside Furniture



SECTION 11

ROADSIDE FURNITURE

11.1 General

Roadside furniture shall be provided as per details given in this Section.

11.2 Road Boundary Stones (RBS)

Road boundary stones shall be provided at the boundary on both sides of the right of way available under the control of the Government. These shall be spaced at 200 m. The boundary stones shall be of cement concrete as per Type Design given in IRC:25. The boundary stones shall be painted with cement primer and enamel paint and marked 'RBS' by paint.

11.3 Kilometre and 200 m Stones

- (i) The Km and 200 m stones shall be provided on one side of the Project Highway. The side of the road on which such stones will be provided, shall be decided by the Government.
- (ii) The design and specifications of Kilometre stone shall conform to IRC:8. The matter to be written on various Kilometre stones and the pattern thereof, shall be as specified in IRC:8.
- (iii) 200 m stones shall be provided at every 200 m distance. The design and specification of 200 m stone shall conform to IRC:26. The matter to be written on various 200 m stones shall be as specified in IRC:26.

11.4 Roadside Railings / Pedestrian Guard Rails

11.4.1 *Pedestrian Guard Rails*

- (i) Pedestrian guardrails are an important design element to prevent indiscriminate crossing and spilling over of pedestrians on to the carriageway. Their judicious use can help to ensure that pedestrians cross the highway at predetermined and safe locations.

As the guardrails would confine the movement of pedestrians to the footpath, it is obligatory that sufficient width of footpath be made available for the use of pedestrians.

- (ii) **Design:** The design shall be such that the guardrails are neat and simple in appearance. The height of guardrail shall be 1.2 m from footpath level. The visibility of the approaching vehicles by the pedestrians as well as the visibility of the pedestrians by the drivers of the approaching vehicles shall be adequate. The railings shall not have any thick horizontal member, other than the baluster to achieve the desired objective.

Pedestrian guardrails may be of reinforced cement concrete, iron tubes, steel channeled sections and pipes, or steel sections appropriate for the environment. Refer to IRC:103.

- (iii) **Application:** Pedestrian guardrails shall be provided at the following locations/situations:
 - (a) **Hazardous locations on straight stretches:** In particularly busy reaches, where the road is congested and vehicles move at a fast pace, guardrails shall be provided on both sides of the carriageway so as to channelize the pedestrians on to the planned crossing locations.
 - (b) **At Junctions/Intersections:** Railing barriers shall be provided to prevent people from crossing the junctions diagonally at signalized intersections. The barrier shall open only at planned crossing facility (at the Zebra Crossing). At unsignalized junctions they shall be provided for sufficient length to guide the pedestrians to the nearest planned pedestrian crossing.
 - (c) **Schools:** Provision of guardrails near schools, where children would otherwise run straight into the road, is essential. If there is a pedestrian crossing or a school crossing patrol nearby, the guardrails shall be extended up to it.
 - (d) **Bus stops, Railway stations, etc.:** Guardrails shall be provided along sidewalks with suitable access at bus stops, railway stations and other areas of heavy pedestrian activity such as cinema houses, stadia, etc. for guiding pedestrians safely in such areas.
 - (e) **Overpass, Subway, etc.:** Guardrails shall be provided at these locations in order to compel the pedestrians to use the facilities provided for them.
 - (f) **Central reserves:** Where there is a central reserve or a median, guardrails shall be erected within it to deter the pedestrians from attempting a crossing.
- (iv) **Gaps/Setback Distance:** The guardrails shall be set back from edge of the carriageway by at least 150 mm.

11.5 Overhead Traffic Signs

11.5.1 Overhead road signs shall be provided in lieu of, or as an adjunct to ground signs where the situation so warrants, for providing warning of hazardous situations, help in regulating traffic, for proper information and guidance of the road users. The following conditions may be considered while deciding about the provision of overhead signs:

- (i) Traffic volume at or near capacity,
- (ii) Restricted sight distance,
- (iii) Built up stretches,
- (iv) Insufficient space for ground mounted signs,
- (v) Distances of important places and route highways at suitable intervals.

11.5.2 The overhead signs shall be reflectorized type, with high intensity retro-reflective sheeting preferably of encapsulated lens type.

11.5.3 Design, location, application, height, vertical and lateral clearances of overhead road signs shall be as specified in Section 800 of MOSRTH Specifications.

11.5.4 Materials for overhead signs support structure and installation shall be in accordance with Section 802 of MOSRTH Specifications.

11.5.5 Location and size of overhead traffic signs shall be specified in Schedule-B of the Concession Agreement.

11.6 Traffic Impact Attenuators

11.6.1 These are protective systems which prevent errant vehicles from impacting fixed objects like the following:

- (i) Bridge abutments.
- (ii) Structural columns of large direction signs.
- (iii) Illumination lamp posts.

11.6.2 In case of two-lane highway, they may be provided where Guard Rail is not appropriate. Necessary safety devices like an assembly of old tyres or steel drums filled with sand can be adopted at suitable location.

11.7 Road Delineators

11.7.1 They provide visual assistance to drivers about the road ahead especially at night. These include pavement markings and post type delineators.

11.7.2 Delineators will include:

- (i) Roadway Indicators - They shall be provided to delineate the edges of the roadway so as to guide drivers about the alignment and particularly, where it might be confusing to drivers.
- (ii) Hazard Markers - They shall be used to define obstructions like guardrails and abutments adjacent to the carriageway and bridges which are narrower than the roadway width.
- (iii) Object Markers - They shall be provided to indicate hazards and obstructions within the vehicle flow path like channelizing islands close to the intersections.

11.7.3 Delineator by pavement markings shall be provided as per IRC:35. Guidepost side delineators shall be provided as per IRC:79 and Section 800 of MOSRTH Specifications.

Section 12

**Landscaping and
Tree Plantation**



SECTION 12

LANDSCAPING AND TREE PLANTATION

12.1 General

The Concessionaire shall plant trees and shrubs of required number and type at the appropriate locations within the Right of Way and in the land earmarked by the Government for afforestation. The Government shall specify the number of trees which are required to be planted by the Concessionaire as compensatory afforestation. The Concessionaire shall also maintain the trees and shrubs in good condition during the Operation Period as per the maintenance schedule. The guidelines given in this Section shall be followed in plantation of trees and shrubs.

12.2 Design Considerations in various locations

12.2.1 *Set-back Distance of Trees and Other Plantation*

Trees on the roadside shall be sufficiently away from the roadway so that they are not a hazard to road traffic or restrict the visibility. Most vulnerable locations in this regard are the inside of curves, junction corners and cut slopes. Trees shall be placed at a minimum distance of 10-12 m from the centre line of the extreme traffic lane, to provide recovery area for the vehicle that runs off the road. A second row of trees 6 m further away will also be desirable and planted, wherever possible. Preferably, the first row of trees shall consist of species with thick shade and other rows of vertical growth type providing thin shade. Expansion of the Project Highway to 4-lanes shall be taken into consideration while locating the trees so that land is free of trees when widening takes place. The distances for alternative rows of trees shall be reckoned from the nearest edge of the pavement. No plantation shall be allowed on the embankment slopes.

12.2.2 *Set-back of Trees on Curves*

In plain terrain, a stopping sight distance of 180 m corresponding to the design speed of 100 km per hour shall be ensured on all curved sections of state highways along the innermost lane. However, where there are site restrictions, their requirement may be reduced to 120 m corresponding to the design speed of 80 km per hour as a special case. The existing trees and vegetation on the sides have to be suitably thinned/ trimmed or even removed, if necessary, and a regular programme of pruning of the offending trees shall be undertaken as part of the maintenance operations.

In the urban section of the Project Highway, trees can be planted on the raised footpaths, provided the distance between the edge of kerb and the nearest edge of tree is not less than 2 m.

In all cases, location of trees shall be checked to ensure that to the motorists, clear visibility of all highway signs/signals is available at all times. Also, the foliage or trees shall not come in the way of roadway lighting.

12.2.3 *Vertical Clearance of Trees and Other Plantations*

For safe traffic operation, the vertical clearance available across the roadway shall be minimum 5 m. From this angle, the probable size of all plants shall be anticipated in advance, at the time of initial planting.

To allow for the effects of growth, wind and rain, trees shall be trimmed to 6 m and 6.5 m above the pavement in rural and urban areas respectively.

12.2.4 *Spacing of Avenue Trees*

The spacing of avenue trees will depend on the type and growth characteristics of trees, requirement of maintenance, penetration of distant views, etc. A range of 10-15 m would meet the requirement for most varieties.

12.2.5 *Choice of Trees*

The following guidelines shall be kept in view while selecting the species of trees to be planted:

- (i) Trees shall be selected with due regard to soil, rainfall, temperature and water level.
- (ii) Trees which become very wide shall be avoided as their maintenance would cause interference with traffic flow.
- (iii) The species must be capable of developing a straight and clean bole upto a height of 2.5 to 3.5 m from the ground level.
- (iv) The selected trees shall, preferably, be fast growing and wind-firm. These shall not be thorny or drop too many leaves.
- (v) The trees shall be deep rooted as shallow roots injure pavements.

- (vi) In urban areas, the species selected shall be of less spreading type, so that these do not interfere with overhead services, clear view of signs and efficiency of roadway lighting.

12.3 Maintenance of Plants

The Concessionaire shall submit scheme for plantation and maintenance of plants and trees to the Independent Engineer for review and comments, if any.



Section 13
Project Facilities



SECTION 13

PROJECT FACILITIES

13.1 General

The requirement of the project facilities to be provided shall be indicated in Schedule-C of the Concession Agreement. This shall include information regarding location and size of the facilities. Land required for provision of facilities shall be acquired by the Government and the date of handing over of the land to the Concessionaire shall be indicated in the Concession Agreement.

13.2 Pedestrian Facilities

13.2.1 General

Pedestrians are vulnerable to being involved in accidents. Therefore, adequate consideration shall be given to their safety through provision of facilities. The facilities for pedestrians given in this Section shall be provided on the Project Highway.

13.2.2 Footpath (Sidewalk)

- (i) The sidewalks shall be provided in the built-up sections, on both sides, by barrier type (non-mountable) kerbs of height 200 mm above the adjacent road surface.
- (ii) The width of sidewalks depends upon the expected pedestrian flow and shall be fixed subject to land availability, but shall not be less than 1.5 m.

13.2.3 Pedestrian Guard Rails

Pedestrian guardrails shall be as specified in Section 11 of this Manual.

13.2.4 Pedestrian Crossing

Where complete segregation of pedestrians from vehicular traffic is not provided, some form of planned road sharing principle shall be applied. Pedestrian crossings shall be provided where they will be well used. Pedestrian crossings shall be suitably integrated with the overall design of the intersection.

The following criteria shall be followed regarding selection of pedestrian crossing:

- (i) At-Grade Pedestrian Crossing (Pedestrian Crosswalk): Pedestrian crosswalks shall be provided at all important intersections and such other locations where

substantial conflict exists between vehicular and pedestrian movements. Wherever possible, the crosswalks shall be at right angles to the carriageway and properly marked so that the pedestrians are subjected to minimum inconvenience. Crosswalks shall not substantially increase the walk distance of pedestrians. Adequate visibility, freedom from obstructions and sufficient space for waiting are the other important requirements for location of crosswalks.

At-grade pedestrian crossings can be uncontrolled or controlled. Uncontrolled pedestrian crossings shall be provided only where the intersection itself is left uncontrolled because of low volumes of both vehicular and pedestrian traffic even during peak hours and where accident records do not indicate any need to segregate vehicular traffic from cross pedestrian traffic. Uncontrolled pedestrian crosswalk shall be marked by studs or paint line.

Controlled form of crossing shall be achieved through provision of Zebra Crossings, whether at an unsignalized or signalized intersection.

- (ii) Zebra Crossing: A Zebra Crossing shall not be sited within 150 m of another such crossing. The Zebra Crossing shall be somewhat set back from the carriageway line. However, the set back distance shall not be so much as to cause an appreciable increase in walking distance for the pedestrians. Pedestrian guardrails may be necessary where the setback distance is appreciable or at the skew crossings.

The width of the Zebra Crossing shall be adequate and shall generally lie within a range of 2.0 m to 4.0 m. The crossing shall, as far as possible, proceed uninterrupted through the median strip. In the event of the median strip being used as pedestrian refuge, adequate width of median shall be provided. In case of raised medians, such portion could be suitably depressed with kerb height not exceeding 150 mm.

In the vicinity of Zebra crossing, guardrails of sufficient length shall be provided to deter pedestrians from crossing the road at any arbitrary point along the road. Fig. 13.1 gives a typical layout of Zebra Crossing at an intersection controlled by channelization only.

13.3 Street Lighting

13.3.1 General

- (i) The Concessionaire shall provide lighting at specified locations of the Project

Highway, using appropriate system and source of electric power as per the requirements of this Section.

- (ii) The Concessionaire shall make suitable arrangements for procuring Power Supply to ensure uninterrupted lighting during night and when visibility is low, including provision of DG sets as standby arrangements.
- (iii) The Concessionaire shall bear all costs of procurement, installation, running and operation cost of all lighting, including cost of energy consumption specified in this Section.

13.3.2 *Specifications*

- (i) Unless stated otherwise elsewhere in this Manual, the minimum average level of illumination on the stretches of Project Highway including Toll Plazas, truck lay-byes, bus bays, etc shall be 30 Lux.
- (ii) The layout of the lighting system together with type of luminaries for different locations shall be prepared by the Concessionaire in such a manner that the minimum illumination level prescribed in para 13.3.2(i) can be achieved and shall be submitted to the Independent Engineer for review and comments, if any.
- (iii) Overhead electrical power and telecommunication lines erected within the ROW by the Concessionaire shall be provided with adequate clearance so that safe use of the highway is not affected.
- (iv) Vertical and horizontal clearances for electrical installations shall conform to IRC:32.
- (v) All the fixtures, wires/cables, lights shall conform to relevant BIS specifications as a minimum. The Concessionaire, may, with the prior review and comments, if any, of the Independent Engineer use fixtures with better specifications.

13.3.3 *Locations where Lighting is to be Provided*

Unless specified otherwise in Schedule-C of the Concession Agreement and elsewhere in this Manual, the Concessionaire shall provide lighting at the following locations of the Project Highway:

- (i) Toll Plaza Area: The lighting in and around Toll Plaza, toll booths, office building, on the approach road, etc. shall be as per Section 10 of this Manual.
- (ii) Truck lay byes: Lighting at the truck lay byes shall be as per para 13.4 of this Manual.

13.4 Truck Lay-byes

13.4.1 General

The Concessionaire shall construct and maintain adequate number and size of truck lay-byes for parking of trucks by the side of the Project Highway as indicated by the Government. The guidelines, as given here, shall be followed in regard to location, size and facilities to be provided at the truck lay-byes.

13.4.2 Location and Size

Truck lay-byes shall, in general, be located near check barriers, interstate borders, places of conventional stops of the truck operators, etc. The places be identified on the basis of field survey and shall have adequate space for facilities as specified in subsequent para 13.4.3 and future growth.

13.4.3 Facilities

The truck lay-byes shall have the following facilities:

- (i) Paved parking,
- (ii) Rest areas with toilets, drinking water,
- (iii) Telephone.

13.4.4 Lighting

The truck lay-byes and 50 m length of the Project Highway on its either side shall be illuminated at night to provide an average illumination of 30 Lux. Suitably designed electric poles having aesthetic appeal and energy saving bulbs may be used to provide required illumination. Alternatively, photo voltaic lamps may be used.

13.5 Bus Bays and Bus Shelters

13.5.1 General

The buses shall be allowed to stop for dropping and picking up passengers only at the bus bays. The Government shall indicate in Schedule-C of the Concession Agreement, the number and broad location of bus bays to be provided by the Concessionaire. The bus bays shall conform to the specifications and standards given in this Section. In cases where bus stands are provided by the concerned State Government Transport Authorities, the Concessionaire shall provide only access road within the right of way.

13.5.2 *Location*

The location of the bus bays shall be fixed on the basis of following principles:

- (i) The bus stops shall be sited away from bridges and other important structures and embankment sections more than 3 m high.
- (ii) As far as possible, bus bays shall not be located on horizontal curves or at the summit of vertical curves.
- (iii) The location shall have good visibility, not less than the safe stopping sight distance.
- (iv) The bus bays shall not be located too close to the road intersections. A gap of 300 m from the tangent point of intersections to start/end of the bus bay shall be desirable. At minor intersections (e.g. junctions with village roads), distance of 60 m may be adopted. However, if a substantial volume of buses is to turn right at the intersection, it is necessary that the bus bay shall be located sufficiently ahead of the intersection so that the buses can be manoeuvred easily from the pick-up stop on the left hand side to the extreme right lane for turning. The location of the bus bays may be fixed after due consultation with the local communities expected to use such facilities.
- (v) At major four-way intersections involving transfer of a substantial number of passengers from one pick-up stop to the other, it might be desirable to construct a single, composite bus stop of suitable design to cater to all the bus routes collectively.
- (vi) In hilly areas, the bus bays shall be located, preferably, where the road is straight on both sides, gradients are flat and the visibility is reasonably good (usually not less than 50 m). Subject to these requirements, it will be advisable to choose locations where it is possible to widen the roadway economically for accommodating bus bays.

13.5.3 *Layout and Design*

- (i) For plain area, typical layouts of bus bays given in Fig. 13.2 shall be adopted. The length "L" shown in Fig. 13.2 shall be 15 m, which shall be increased in multiples of 15 m if more than one bus is likely to halt at the bus bay at one time.
- (ii) For hilly areas, where there is a general constraint on space, the layout indicated in Fig. 13.3 may be adopted.

- (iii) Bus bays shall be provided on both sides of the Project Highway for each direction of travel independently, so that the buses do not have to cut across the road. Bus bays on opposite sides shall be staggered to a certain extent to avoid undue congestion on the highway. At intersections, the bus bays for up and down direction shall be located on farther sides of the intersection.
- (iv) The bus bay shall be provided with a shelter for passengers. The shelter shall be structurally safe and aesthetic in appearance, while also being functional so as to protect the waiting passengers adequately from sun, wind and rain. If the shelter is constructed on the hillside, slopes shall be properly dressed and suitably protected to avoid slips. The shelter shall be set back from the kerb line by at least 500 mm.

13.5.4 *Pavement*

The pavement in the bus bays shall have adequate crust with respect to the wheel loads expected. Also, the surfacing shall be strong enough to withstand forces due to frequent braking and acceleration by the buses. The colour and texture of the bus bay surfacing shall be preferably distinctive from that of the main carriageway.

13.5.5 *Drainage*

- (i) The bus bays shall have proper cross slope to drain off the excess water. No water, which is likely to splash on the waiting passengers, shall be allowed to collect near the bus shelters.
- (ii) Suitable kerb gutter section with requisite longitudinal slope and outlets at intervals to ensure quick disposal of water shall be provided.

13.5.6 *Road Markings*

Pavement markings with thermoplastic paint having glass beads shall be provided at the bus stops as shown in Figs. 13.2 and 13.3 with the word 'BUS' written prominently on the pavement. Pedestrian crossings shall be marked slightly behind the standing position of the buses in order to reduce pedestrian conflicts. The kerbs shall be marked with continuous yellow line to indicate "No Parking".

13.6 **Cattle Crossings**

Facility for cattle crossings shall be provided as specified in para 2.14.3 of this Manual.

13.7 Traffic Aid Posts

Traffic Aid Posts shall be established at Toll Plaza locations in accordance with the provisions of the Concession Agreement.

13.8 Medical Aid Posts

Medical Aid Posts shall be established at Toll Plaza locations in accordance with the provisions of the Concession Agreement.

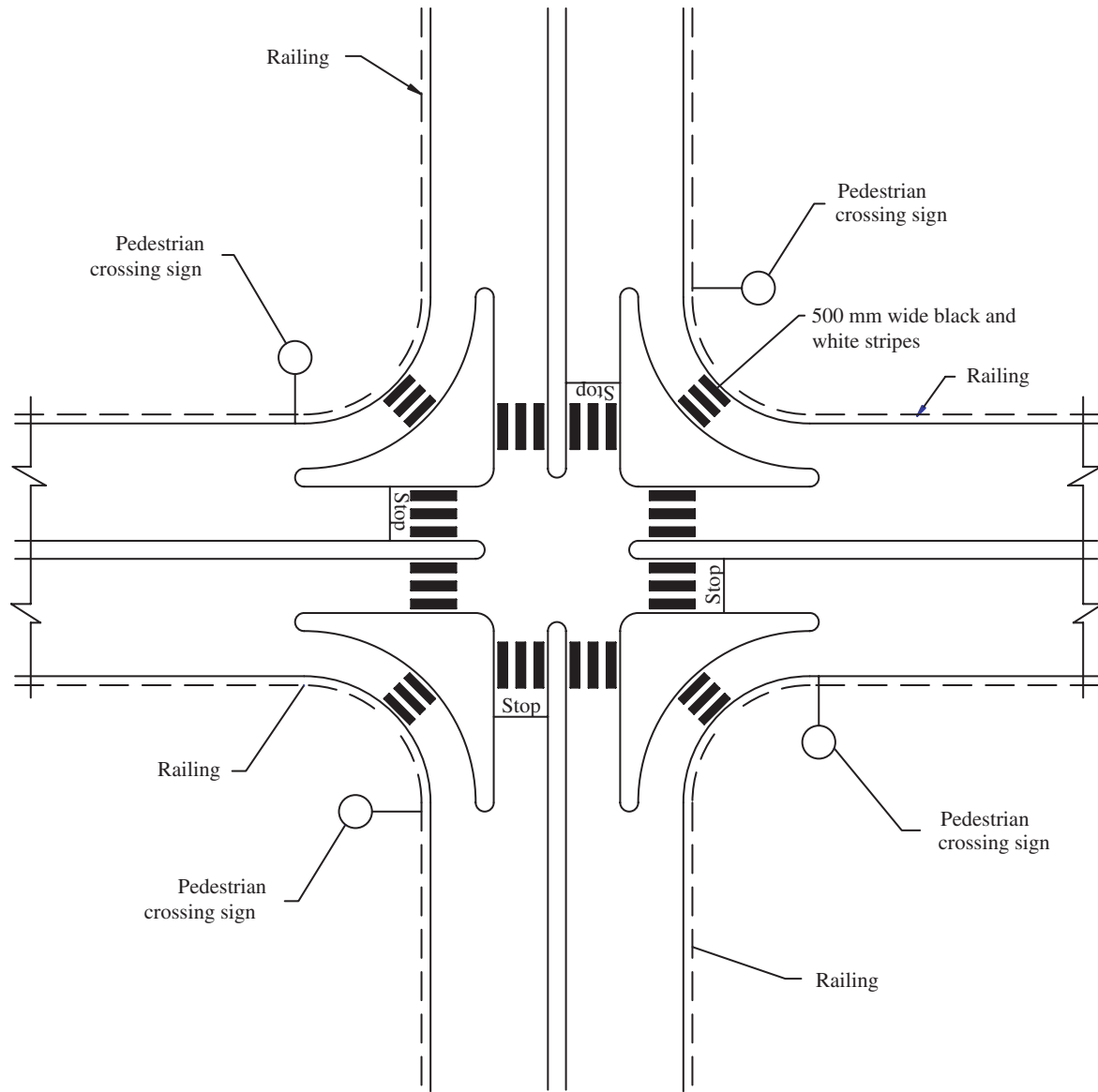
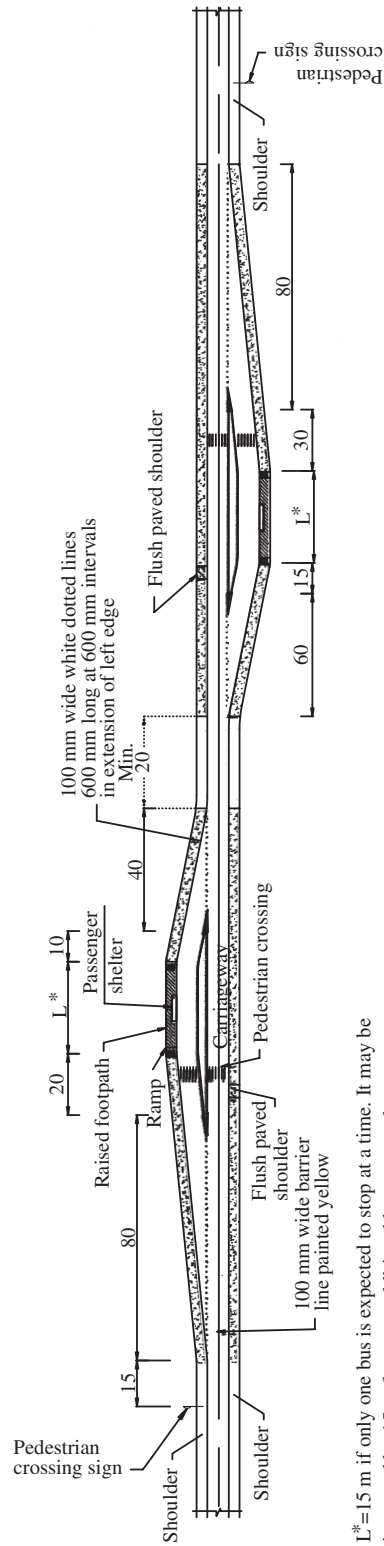

Fig. 13.1 : Arrangement of zebra crossing (4-lane) in built up area



L*=15 m if only one bus is expected to stop at a time. It may be increased by 15 m for every additional bus expected to stop.

Note:
All dimensions are in metres
except as shown otherwise.

Fig. 13.2 : Layout of staggered pick-up bus stop

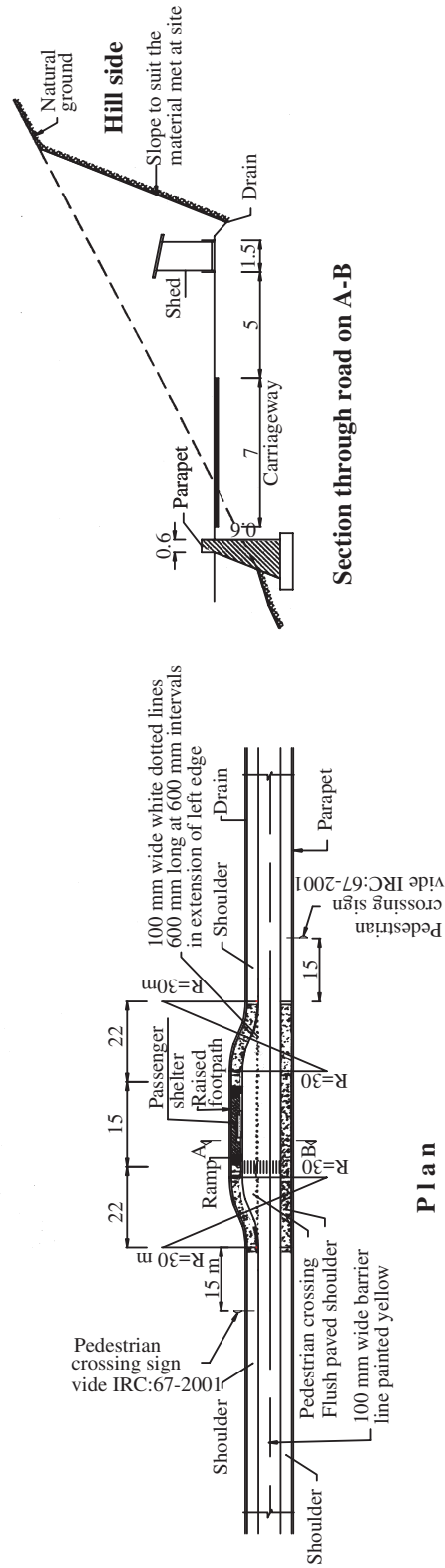

Fig. 13.3 : Layout of pick-up bus stop in hilly area

Section 14

**Special Requirements for
Hill Roads**



SECTION 14

SPECIAL REQUIREMENTS FOR HILL ROADS

14.1 General

14.1.1 The Concessionaire shall pay due attention to geo-technical, environmental and social aspects of hill roads and take appropriate measures to ensure the following: (The guidelines given in IRC:SP: 48 may be referred to, for details).

- (i) Stability against geological disturbances.
- (ii) Prevention of soil erosion.
- (iii) Provision of efficient drainage and preservation of natural drainage system.

14.1.2 If there are any landslide prone areas along the road alignment, adequate investigation shall be undertaken and appropriate remedial measures shall be provided as per guidelines given in IRC:SP: 48.

14.1.3 Where any new construction/realignment is involved, the alignment shall avoid large scale cuttings and fillings and follow the profile of land, as far as possible.

Areas having potential landslide or settlement problems shall be avoided. Adverse impact on the environment shall be reduced by adopting proper mitigation measures. Refer to guidelines given in IRC:SP: 48.

14.1.4 Unstable hill slopes shall be adequately addressed by providing appropriate bio-engineering and stabilization measures.

14.1.5 Necessary safeguard shall be taken to protect ecology sensitive areas like wild life and bird sanctuaries, reserve forests, national parks, etc.

14.1.6 Provision of protective structures for traffic such as parapets, railings, roadside safety barriers, boulder nets, etc. shall be provided, where necessary.

14.2 Set back distance at horizontal curves

Requisite sight distance should be available across the inside of horizontal curves. Lack of visibility in the lateral direction may arise due to obstructions like walls, cut-slopes, wooded areas, etc. Set back distance from the central line of the carriageway, within which the offending obstructions should be cleared to ensure the needed visibility, can be determined using the Equation given in IRC:52.

14.3 Grade compensation at curves

At horizontal curves, the gradient shall be eased by applying the grade compensation correction for gradients steeper than 4% in accordance with IRC:52.

14.4 Hairpin Bends

Hairpin bends, where unavoidable, may be designed either as a circular curve with transition curves at each end or as a compound circular curve.

Design criteria given in IRC:52 shall be adopted for the design of hairpin bends. At hairpin bends the full roadway width should be surfaced.

14.5 Climbing Lane

Climbing lane shall be provided, where specified in Schedule-B of the Concession Agreement, in order to address the necessity of making available separate lane for safe overtaking for vehicle travelling uphill.

Proper signing and road markings shall be provided to ensure that the absolute right of way for climbing vehicles is available.

- 14.6 Heavy rock blasting should be avoided. Controlled blasting shall be resorted to. Blasting shall be supervised by experienced personnel. Blasting and related operations shall be carried out in accordance with Clause 302 of MOSRTH Specifications.
- 14.7 Cut slopes shall be rendered stable in the construction stage itself, by cutting at the correct angle and benching etc. including slope stabilizing structures like drains, breast walls, pitching, etc.
- 14.8 Where it is necessary to cross hills or high ridges, the various alternatives including construction of tunnel to avoid deep cuts shall be considered and the most preferred alternative shall be chosen. The alternative to be followed shall be indicated by the Government in Schedule-B of the Concession Agreement. Where road is to be taken through tunnel, its salient details shall be indicated in Schedule-B of the Concession Agreement.
- 14.9 For drainage of water from roadside, an effective system of drainage shall be constructed to lead the run-off to natural water courses. In particular, catch water

drains (Refer to para 6.5 of this Manual) shall be provided above the cut slopes. It shall be ensured that water is not drained into villages and cultivated land. Location of cross drains and culverts should be so chosen as to avoid erosion of the outlet. Erosion control works like drop walls, apron at out-fall points along with pitching/paving of the channel shall be provided where required.

14.10 Retaining Walls

14.10.1 Retaining walls shall be provided:

- (i) To support the down hill side unstable strata or fills,
- (ii) To achieve width of roadway, where cutting into hill is restricted,
- (iii) To arrest damage caused to the valley side and the road, by under cutting by a stream or other water course,
- (iv) At valley points, where water flows over the road,
- (v) At places where the valley side gets saturated in the monsoons and is likely to result in slips and damage to the road,
- (vi) At any other locations warranting provision of retaining walls.

14.10.2 For general features, arrangement and design, guidelines given in IRC:SP: 48 may be referred to.

14.11 Construction of apron, pitching, flooring shall conform to Clauses 2503 to 2507 of MOSRTH Specifications.

14.12 Disposal sites shall be identified for disposal of waste, debris, etc. Tipping of waste into valley sides, stream channels, water bodies, and forest areas shall not be resorted to.



Appendices



APPENDIX-1
(Reference Para 1.12)

List of paras for preparing Schedules of the Concession Agreement

| Section | Para | Particulars to be specified |
|----------------|-----------------------|--|
| Section 1 | 1.14 (i), (ii), (iii) | Two laning or Two laning Plus option |
| Section 2 | 2.1 (ii) (a) | Requirement of 4 laning in stretches passing through built up areas, and such stretches. |
| | 2.1 (ii) (b) | Construction of bypass, alignment and land for the bypass. |
| | 2.1 (v) | Land for geometric improvements, and such stretches |
| | 2.2.3 | Land for geometric improvements and such stretches for ruling design speed |
| | 2.3 | Right of way |
| | 2.5.2 (i) | Provision of foot paths in built up sections |
| | 2.6.1 | Width of Roadway if different from that given in Para 2.6.1 |
| | 2.13.1 | Provision of Service Roads and Stretches |
| | 2.14.1 | Location and other features of grade separated structures |
| | 2.14.2 | Type of Structures for Vehicular under/over passes |
| | 2.14.3 (i) | Location of Cattle and Pedestrian Underpasses/ overpasses |
| Section 3 | 3.1 and 3.2 | Type of Intersection and land for intersection |
| | 3.3.1 (ii) | Location and other features of grade separated intersections without ramps. |
| | 3.3.3 | Length of viaduct at grade separated structures |
| | 3.4.1 (iii) | Location and other features of interchanges |
| | 3.4.5 | Length of viaduct at grade separated structures (Inter changes with ramps) |
| Section 4 | 4.2.2 (i) | Sections of existing road to be raised |
| Section 5 | 5.1.2 | Requirement of CC Pavement, and design and maintenance requirements |

| Section | Para | Particulars to be specified |
|------------|--|---|
| Section 7 | 5.9.7 | Stretches to be reconstructed |
| | 5.9.9 | Width of Paved Shoulder if different from 1.5 m |
| | 7.1 (ii) | Width of structures of more than 60 m length |
| | 7.1 (iii) | Requirement of bridge with foot paths |
| | 7.1 (iv) | Bridge which may not to be high level |
| | 7.1 (vi) | Railway level Crossings not to be replaced by ROB/ RUB |
| | 7.1 (viii) | Utility services to be carried over the structures |
| | 7.3.1 (i) | Distressed culverts to be reconstructed |
| | 7.3.2 (i) | Distressed bridges to be reconstructed |
| | 7.3.2 (ii) | Existing bridges to be widened |
| | 7.18 (iv) | Requirement of Crash barriers for existing bridges |
| | 7.18 (v) | Parapets/Railings of existing bridges to be repaired/ replaced. |
| | 7.22 | Measures for protecting bridges in marine environment |
| 7.23 (i) | Structures to be repaired/strengthened, nature and extent of repairs | |
| Section 9 | 9.3.1 | Specifications of reflecting sheeting |
| Section 10 | 10.2 & 10.3 | Location of Toll Plaza and land for Toll Plaza |
| Section 11 | 11.5.5 | Location and size of overhead traffic signs |
| Section 12 | 12.1 | Number of trees to be planted |
| Section 13 | 13.1 | Project facilities and land for providing project facilities |
| | 13.3.3 | Situations/locations where lighting to be provided |
| | 13.4 | Location and number of truck lay-byes to be provided. |
| | 13.5.1 | Location and number of bus bays to be provided |
| Section 14 | 14.5 | Requirement of Climbing lane |
| | 14.8 | Alignment/Construction of tunnel and its salient details |

APPENDIX-2
(Reference Para 1.5)

List of IRC Publications

| S. No. | Code/ Document No. | Title of the Publication |
|--|-------------------------------|---|
| 1. ROADS | | |
| 1 (A) Transport Planning, Traffic Assessment & Policies | | |
| 1. | IRC:3-1983 | Dimensions & Weights of Road Design Vehicles (First Revision) |
| 2. | IRC:9-1972 | Traffic Census on Non-Urban Roads (First Revision) |
| 1 (B) Road Geometric & Design Features | | |
| 1. | IRC:12-1983 | Recommended Practice for Location and Layout of Roadside Motor-Fuel Filling and Motor-Fuel Filling-cum-Service Stations (Second Revision) |
| 2. | IRC:32-1969 | Standard for Vertical and Horizontal Clearances of Overhead Electric Power and Telecommunication Lines as Related to Roads |
| 3. | IRC:38-1988 | Guidelines for Design of Horizontal Curves for Highways and Design Tables (First Revision) |
| 4. | IRC:39-1986 | Standards for Road-Rail Level Crossings (First Revision) |
| 5. | IRC:54-1974 | Lateral and Vertical Clearances at Underpasses for Vehicular Traffic |
| 6. | IRC:64-1990 | Guidelines for Capacity of Roads in Rural Areas (First Revision) |
| 7. | IRC:66-1976 | Recommended Practice for Sight Distance on Rural Highways |
| 8. | IRC:70-1977 | Guidelines on Regulation and Control of Mixed Traffic in Urban Areas |
| 9. | IRC:73-1980 | Geometric Design Standards for Rural (Non-Urban Highways) |
| 10. | IRC:80-1981 | Type Designs for Pick-up Bus Stops on Rural (i.e. Non-Urban) Highways |

| S. No. | Code/ Document No. | Title of the Publication |
|---|---------------------------|--|
| 11. | IRC:86-1983 | Geometric Design Standards for Urban Roads in Plains |
| 12. | IRC:98-1997 | Guidelines on Accommodation of Utility Services on Roads in Urban Areas (First Revision) |
| 13. | IRC:99-1988 | Tentative Guidelines on the Provision of Speed Breakers for Control of Vehicular Speeds on Minor Roads |
| 14. | IRC:103-1988 | Guidelines for Pedestrian Facilities |
| 15. | IRC:106-1990 | Guidelines for Capacity of Urban Roads in Plain Areas |
| 16. | IRC:SP: 23-1983 | Vertical Curves for Highways |
| 17. | IRC:SP: 41-1994 | Guidelines on Design of At-Grade Intersections in Rural & Urban Areas |
| 1 (C) Road Markings | | |
| 1. | IRC:30-1968 | Standard Letters and Numerals of Different Heights for Use on Highway Signs |
| 2. | IRC:35-1997 | Code of Practice for Road Markings (With Paints) (First Revision) |
| 1 (D) Road Furniture & Signage | | |
| 1. | IRC:8-1980 | Type Designs for Highway Kilometer Stones (Second Revision) |
| 2. | IRC:25-1967 | Type Designs for Boundary Stones |
| 3. | IRC:26-1967 | Type Design for 200-Metre Stones |
| 4. | IRC:31-1969 | Route Marker Signs for State Routes |
| 5. | IRC:67-2001 | Code of Practice for Road Signs (First Revision) |
| 6. | IRC:79-1981 | Recommended Practice for Road Delineators |
| 7. | IRC:SP:31-1992 | New Traffic Signs |
| 1 (E) Road Safety & Traffic Management | | |
| 1. | IRC:53-1982 | Road Accident Forms A-1 and 4 (First Revision) |
| 2. | IRC:SP:27-1984 | Report Containing Recommendations of IRC Regional Workshops on Highway Safety |

| S. No. | Code/ Document No. | Title of the Publication |
|--|---------------------------|---|
| 3. | IRC:SP:32-1988 | Road Safety for Children (5-12 Years old) |
| 4. | IRC:SP:44-1994 | Highway Safety Code |
| 5. | IRC:SP:55-2001 | Guidelines for Safety in Construction Zones |
| 1 (F) Embankment Construction & Erosion Control | | |
| 1. | IRC:10-1961 | Recommended Practice for Borrow pits for Road Embankments Constructed by Manual Operation |
| 2. | IRC:28-1967 | Tentative Specifications for the Construction of Stabilised Soil Roads with Soft Aggregate in Areas of Moderate and High Rainfall |
| 3. | IRC:33-1969 | Standard Procedure for Evaluation and Condition Surveys of Stabilised Soil Roads |
| 4. | IRC:36-1970 | Recommended Practice for Construction of Earth Embankments for Road Works |
| 5. | IRC:56-1974 | Recommended Practice for Treatment of Embankment Slopes for Erosion Control |
| 6. | IRC:75-1979 | Guidelines for the Design of High Embankments |
| 7. | IRC:SP:58-2001 | Guidelines for Use of Flyash in Road Embankments |
| 1 (G) Non-Bituminous Base and Sub-Base | | |
| 1. | IRC:19-2005 | Standard Specification and Code of Practice for Water Bound Macadam (Third Revision) |
| 2. | IRC:49-1973 | Recommended Practice for the Pulverization of Black Cotton Soils for Lime Stabilisation |
| 3. | IRC:50-1973 | Recommended Design Criteria for the Use of Cement Modified Soil in Road Construction |
| 4. | IRC:51-1992 | Guidelines for the Use of Soil Lime Mixes in Road Construction (First Revision) |
| 5. | IRC:60-1976 | Tentative Guidelines for the Use of Lime- Flyash Concrete as Pavement Base or Sub-Base |

| S. No. | Code/ Document No. | Title of the Publication |
|---------------|---------------------------|---|
| 6. | IRC:63-1976 | Tentative Guidelines for the Use of Low Grade Aggregates and Soil Aggregates Mixtures in Road Pavement Construction |
| 7. | IRC:74-1979 | Tentative Guidelines for Lean-Cement Concrete and Lean-Cement Flyash Concrete as a Pavement Base or Sub-Base |
| 8. | IRC:88-1984 | Recommended Practice for Lime Flyash Stabilised Soil Base/ Sub-Base in Pavement Construction |
| 9. | IRC:109-1997 | Guidelines for Wet Mix Macadam |
| 10. | IRC:SP:59-2002 | Guidelines for Use of Geotextiles in Road Pavements and Associated Works |

1 (H) Design, Construction and Maintenance of Flexible Pavements

| | | |
|-----|-------------|--|
| 1. | IRC:14-2004 | Recommended Practice for Open Graded Premix Carpet (Third Revision) |
| 2. | IRC:16-1989 | Specification for Priming of Base Course with Bituminous Primers (First Revision) |
| 3. | IRC:19-2005 | Standard Specifications and Code of Practice of Water Bound Macadam (Third Revision) |
| 4. | IRC:20-1966 | Recommended Practice for Bituminous Penetration Macadam (Full Grout) |
| 5. | IRC:27-1967 | Tentative Specifications for Bituminous Macadam (Base & Binder Course) |
| 6. | IRC:34-1970 | Recommendations for Road Construction in Waterlogged Areas |
| 7. | IRC:37-2001 | Guidelines for the Design of Flexible Pavements (Second Revision) |
| 8. | IRC:47-1972 | Tentative Specification for Built-up Spray Grout |
| 9. | IRC:55-1974 | Recommended Practice for Sand-Bitumen Base Courses |
| 10. | IRC:81-1997 | Tentative Guidelines for Strengthening of Flexible Road Pavements Using Benkelman Beam Deflection Technique (First Revision) |

| S. No. | Code/ Document No. | Title of the Publication |
|--|---------------------------|---|
| 11. | IRC:82-1982 | Code of Practice for Maintenance of Bituminous Surfaces of Highways |
| 12. | IRC:95-1987 | Specification for Semi-Dense Bituminous Concrete |
| 13. | IRC:110-2005 | Standard Specifications and Code of Practice for Design and Construction of Surface Dressing |
| 14. | IRC:SP:53-2002 | Guidelines on Use of Polymer and Rubber Modified Bitumen in Road Construction (First Revision) |
| 1 (I) Design, Construction and Maintenance of Cement Concrete Pavements | | |
| 1. | IRC:15-2002 | Standard Specifications and Code of Practice for Construction of Concrete Roads (Third Revision) |
| 2. | IRC:44-1976 | Tentative Guidelines for Cement Concrete Mix Design for Pavements (for Non-Air Entrained and Continuously Graded Concrete) (First Revision) |
| 3. | IRC:57-1974 | Recommended Practice for Sealing of Joints in Concrete Pavements |
| 4. | IRC:58-2002 | Guidelines for the Design of Plain Jointed Rigid Pavements for Highways (Second Revision) |
| 5. | IRC:61-1976 | Tentative Guidelines for the Construction of Cement Concrete Pavements in Hot Weather |
| 6. | IRC:68-1976 | Tentative Guidelines on Cement-Flyash Concrete for Rigid Pavement Construction |
| 7. | IRC:77-1979 | Tentative Guidelines for Repair of Concrete Pavements Using Synthetic Resins |
| 8. | IRC:84-1983 | Code of Practice for Curing of Cement Concrete Pavements |
| 9. | IRC:91-1985 | Tentative Guidelines for Construction of Cement Concrete Pavements in Cold Weather |
| 10. | IRC:SP:49-1998 | Guidelines for the Use of Dry Lean Concrete as Sub-base for Rigid Pavement |

| S. No. | Code/ Document No. | Title of the Publication |
|---|---------------------------|---|
| 11. | IRC:SP:62-2004 | Guidelines for the Design and Construction of Cement Concrete Pavement for Rural Roads |
| 12. | IRC:SP:63-2004 | Guidelines for the Use of Interlocking Concrete Block Pavement |
| 13. | IRC:SP:68-2005 | Guidelines for Construction of Roller Compacted Concrete Pavements |
| 1 (J) Project Preparation, Contract Management and Quality Control | | |
| 1. | IRC:42-1972 | Proforma for Record of Test Values of Locally Available Pavement Construction Materials |
| 2. | IRC:SP:16-2004 | Guidelines for Surface Evenness of Highway Pavements (First Revision) |
| 3. | IRC:SP:19-2001 | Manual for Survey, Investigation and Preparation of Road Projects (Second Revision) |
| 4. | IRC:SP:57-2000 | Guidelines for Quality Systems for Road Construction |
| 5. | IRC:SP:68-2005 | Guidelines for Construction of Roller Compacted Concrete Pavements |
| 1 (K) Hill Roads | | |
| 1. | IRC:52-2001 | Recommendations about the Alignment Survey and Geometric Design of Hill Roads (Second Revision) |
| 2. | IRC:SP:48-1998 | Hill Road Manual |
| 1 (L) Road Drainage | | |
| 1. | IRC:SP:42-1994 | Guidelines on Road Drainage |
| 2. | IRC:SP:50-1999 | Guidelines on Urban Drainage |
| 1 (M) Road Machinery | | |
| 1. | IRC:43-1972 | Recommended Practice for Tools, Equipment and Appliances for Concrete Pavement Construction |
| 2. | IRC:72-1978 | Recommended Practice for Use and Upkeep of Equipment, Tools and Appliances for Bituminous Pavement Construction |

| S. No. | Code/ Document No. | Title of the Publication |
|---------------|---------------------------|---|
| 3. | IRC:90-1985 | Guidelines of Selection, Operation and Maintenance of Bituminous Hot Mix Plant |
| 4. | IRC:SP:22-1980 | Recommendation for the Sizes for each Type of Road Making Machinery to cater to the General Demand of Road Works |
| 5. | IRC:SP:25-1984 | Gopi and his Road Roller-Guidelines on Maintenance of Road Rollers |
| 6. | IRC:SP:29-1994 | Directory of Indigenous Manufacturers of Road/ Bridge Construction Machinery & Important Bridge Components (First Revision) |
| 7. | IRC:SP:34-1989 | General Guidelines about the Equipment for Bituminous Surface Dressing |

2. BRIDGES

2 (A) Codes of Practice

| | | |
|----|-------------|--|
| 1. | IRC:5-1998 | Standard Specifications and Code of Practice for Road Bridges, Section I - General Features of Design (Seventh Revision) |
| 2. | IRC:6-2000 | Standard Specifications and Code of Practice for Road Bridges, Section II - Loads and Stresses (Fourth Revision) |
| 3. | IRC:18-2000 | Design Criteria for Prestressed Concrete Bridges (Post Tensioned Concrete) Third Revision) |
| 4. | IRC:21-2000 | Standard Specifications and Code of Practice for Road Bridges, Section III - Cement Concrete (Plain and Reinforced) (Third Revision) |
| 5. | IRC:22-1986 | Standard Specifications and Code of Practice for Road Bridges, Section VI - Composite Construction (First Revision) |
| 6. | IRC:24-2001 | Standard Specifications and Code of Practice for Road Bridges, Section V - Steel Road Bridges (Second Revision) |
| 7. | IRC:40-2002 | Standard Specifications and Code of Practice for Road Bridges, Section IV - Brick, Stone and Block Masonry (Second Revision) |

| S. No. | Code/ Document No. | Title of the Publication |
|---------------|---------------------------|--|
| 8. | IRC:45-1972 | Recommendation for Estimating the Resistance of Soil below Maximum Scour level in the Design of Well Foundation of Bridges |
| 9. | IRC:78-2000 | Standard Specifications and Code of Practice for Road Bridges, Section VII - Foundations and Substructures (Second Revision) |
| 10. | IRC:83-1999 (Part-I) | Standard Specifications and Code of Practice for Road Bridges, Section IX - Bearings, Part I : Metallic Bearings (First Revision) |
| 11. | IRC:83-1987 (Part II) | Standard Specifications and Code of Practice for Road Bridges, Section IX - Bearings, Part II: Elastomeric Bearings |
| 12. | IRC:83-2002 (Part III) | Standard Specifications and Code of Practice for Road Bridges, Section IX - Bearings, Part III: Pot, Pot-cum-PTFE, Pin and Metallic Guide Bearings |
| 13. | IRC:87-1984 | Guidelines for the Design and Erection of False work for Road Bridges |
| 14. | IRC: 89-1997 | Guidelines for Design and Construction of River Training & Control Works for Road Bridges (First Revision) |
| 15. | IRC:SP:69-2005 | Guidelines & Specifications for Expansion Joints. |
| 16. | IRC:SP:70-2005 | Guidelines for the Use of High Performance Concrete in Bridges. |
| 17. | IRC:SP:71-2006 | Guidelines for Design and Construction of Precast Pre-Tensioned Girders for Bridges. |

2 (B) Inspection, Maintenance & Rehabilitation

| | | |
|----|----------------|--|
| 1. | IRC:SP:35-1990 | Guidelines for Inspection and Maintenance of Bridges |
| 2. | IRC:SP:40-1993 | Guidelines on Techniques for Strengthening and Rehabilitation of Bridges |
| 3. | IRC:SP:52-1999 | Bridge Inspector's Reference Manual |

| S. No. | Code/ Document No. | Title of the Publication |
|---|--|--|
| 2 (C) Project Preparation, Contract Management & Quality Control | | |
| 1. | IRC:SP:47-1998 | Guidelines on Quality Systems for Road Bridges (Plain, Reinforced, Prestressed and Composite Concrete) |
| 2. | IRC:SP:54-2000 | Project Preparation Manual for Bridges |
| 2 (D) Other Important Publications | | |
| 1. | IRC:7-1971 | Recommended Practice for Numbering Bridges and Culverts (First Revision) |
| 2. | IRC:SP:13-2004 | Guidelines for the Design of Small Bridges and Culverts (First Revision) |
| 3. | IRC:SP:51-1999 | Guidelines for Load Testing of Bridges |
| 3. MOSRTH Publications | | |
| 1. | MOSRTH Specifications for Road and Bridge Works, 2001 (Fourth Revision) | |
| 2. | MOSRTH Standard Plans for Single, Double and Triple Cell Box Culverts with and without Earth cushion | |
| 3. | MOSRTH Type Designs for Intersections on National Highways.1992 | |
| 4. | Manual for Safety in Road Design | |

